



Precision[®]

A Quality Insured Name



Life begins with hopes and dreams.....

Finest Quality Dental Instruments

Precision Instruments

Life Saver Supplies - A division of

Life Saver Solutions, Inc.

Los Angeles, California

LIFE, HEALTH, HAPPINESS

If we do not have hope we can not get well and we will stop dreaming. If we stop dreaming we will give up hope.

Our brothers and sisters in the medical profession are blessed with providing us with their professional knowledge allowing us to have hope and keep dreaming with our improved health they have given us.

All of humanity are in the debt to the men and women of the medical profession for their kindness, understanding and knowledge that they have given to their fellow man from their heart.



Precision®

Introduction:

We are the manufacturers of complete lines of the finest quality Surgical, Dental & Veterinary Instruments. Our corporate office is located in Anaheim CA, minutes from Disneyland.

Manufacturing:

All our instruments are manufactured from Surgical Grade German Stainless Steel. Our skilled craftsmen, with great precision, hand craft all our instruments in our ISO 9001-2008 approved facilities.

Catering The Market Needs:

We have developed two lines to meet the requirements of our customers.

- (1) **PREMIUM LINE**, O.R grade instruments in Satin Finish for surgical needs to use.
- (2) **VALUE-LINE**, For Nurses, Physician's Assistants and Hospitals, the same product line in Mirror Finish.

Product Range

We have carefully selected about 1,100 commonly used instruments to present to you. However, we have molds for over 10,000 items. If you don't find what you need in this catalog, please provide us with a sample, sketch or even a competitor reference number, we will produce a counter sample for your review.

Speciality:

Our focus and strength is to serve our customers with the highest quality instruments at FACTORY DIRECT PRICES, Our customers achieve very attractive profit margins while reducing their inventory cost. A considerable segment of our business is O.E.M / Private label. We assist our customers in promoting their brand through total support and great enthusiasm.

Precision Warranty Program:

Due to strict adherence to our Quality Control standards during the manufacturing process, we feel confident offering our customers LIFE-TIME WARRANTY on **PREMIUM** line and One Year Warranty on **VALUE-LINE** instruments.

Customer Satisfaction is Our Obsession:

We continuously strive to make our Distributors/Customers successful. We entertain and appreciate any and all suggestions and recommendations.



EXTRACTING FORCEPS (English Pattern)

- Щипцы экстракционные (английская форма)
- Daviers (Forme Anglaise)
- Zahnzangen (Englische Form)

- Щипці екстракційні (англійська форма)
- Forceps de Extracción (Forme Inglesa)
- استخراج الملقط (تمط اللغة الإنجليزية)



786-101
Fig. 1
Upper central
& canines



786-102
Fig. 2
Upper laterals
& bicuspids



786-103
Fig. 3
Upper incisors
& canines



786-104
Fig. 4
Lower incisors
& canines

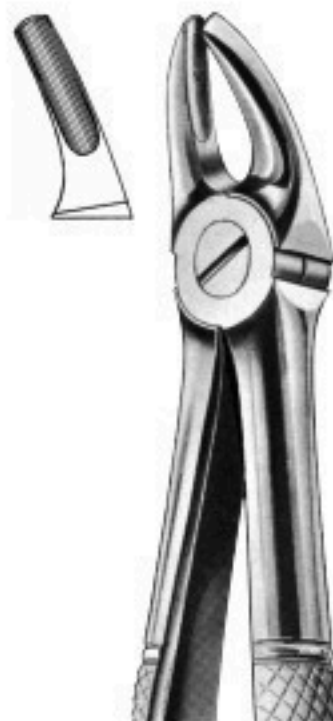

786-105
Fig. 7
Upper primolars



786-106
Fig. 8
Lower primolars



786-107
Fig. 13
Lower primolars



EXTRACTING FORCEPS (English Pattern)

- Щипцы экстракционные (английская форма)
- Daviers (Forme Anglaise)
- Zahnzangen (Englische Form)

- Щипці екстракційні (англійська форма)
- Forceps de Extracción (Forme Inglesa)
- استخراج الملقط (تمط اللغة الإنجليزية)



786-108
Fig 17
Right upper molars



786-109
Fig. 18
left upper molars

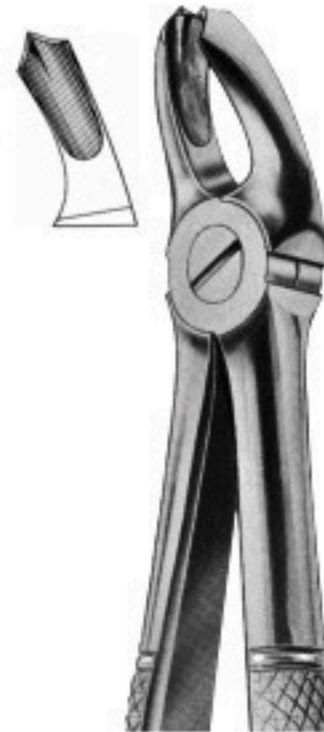

786-110
Fig 18A
upper molars



786-111
Fig. 19
upper wisdoms



786-112
Fig. 20
Lower wisdoms



786-113
Fig. 21
Lower molars



786-114
Fig. 22
Lower molars
Hawk's bill



EXTRACTING FORCEPS (English Pattern)

- Щипцы экстракционные (английская форма)
- Daviers (Forme Anglaise)
- Zahnzangen (Englische Form)

- Щипці екстракційні (англійська форма)
- Forceps de Extracción (Forme Inglesa)
- استخراج الملقط (تمط اللغة الإنجليزية)



786-115
Fig. 23
Right lower molar



786-116
Fig. 24
Right lower molar



786-117
Fig. 29
Upper roots
& incisors

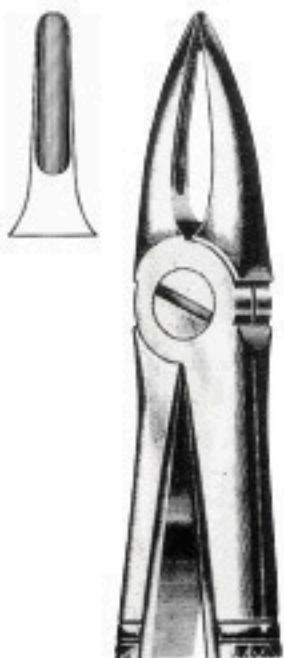

786-118
Fig. 29N
Roots of upper
incisors



786-119
Fig. 30
Upper roots &
incisors



786-120
Fig. 31
Lower roots



786-121
Fig. 32
Lower molars



EXTRACTING FORCEPS (English Pattern)

- Щипцы экстракционные (английская форма)
- Daviers (Forme Anglaise)
- Zahnzangen (Englische Form)

- Щипці екстракційні (англійська форма)
- Forceps de Extracción (Forme Inglesa)
- استخراج الملقط (تمط اللغة الإنجليزية)



786-122
Fig. 33
Lower roots



786-123
Fig. 33A
Lower roots

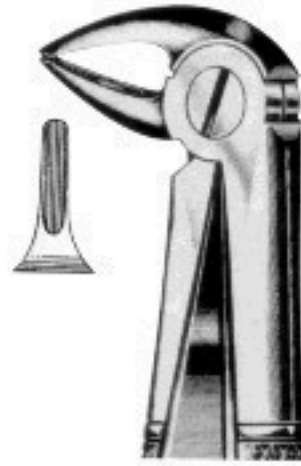

786-124
Fig. 33C
Lower roots



786-125
Fig. 33M
Lower roots
with long beak



786-126
Fig. 41
Upper roots



786-127
Fig. 44
Upper roots



786-128
Fig. 45
Lower roots



786-129
Fig. 51
Upper roots



EXTRACTING FORCEPS (English Pattern)

- Щипцы экстракционные (английская форма)
- Daviers (Forme Anglaise)
- Zahnzangen (Englische Form)

- Щипці екстракційні (англійська форма)
- Forceps de Extracción (Forme Inglesa)
- استخراج الملقط (تمط اللغة الإنجليزية)



786-130
Fig. 51 A
Upper roots
narrow beak

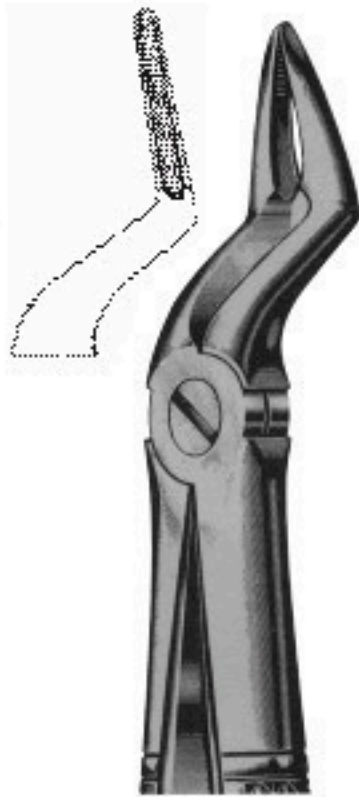

786-131
Fig. 51 C
Upper roots



786-132
Fig. 52
Upper roots & canines
with wider beak



786-133
Fig. 52 A
upper teeth &
resection



786-134
Fig. 55
Separating upper
molars roots



786-135
Fig. 56
Separating lower
molars roots



786-136
Fig. 67
Upper wisdoms



786-137
Fig. 67 A
Upper wisdoms



EXTRACTING FORCEPS (English Pattern)

- Щипцы экстракционные (английская форма)
- Daviers (Forme Anglaise)
- Zahnzangen (Englische Form)

- Щипці екстракційні (англійська форма)
- Forceps de Extracción (Forme Inglesa)
- استخراج الملقط (تمط اللغة الإنجليزية)



786-138
Fig. 68
Lower roots



786-139
Fig. 73
Lower molars



786-140
Fig. 74
Lower roots



786-141
Fig. 74M
Lower roots

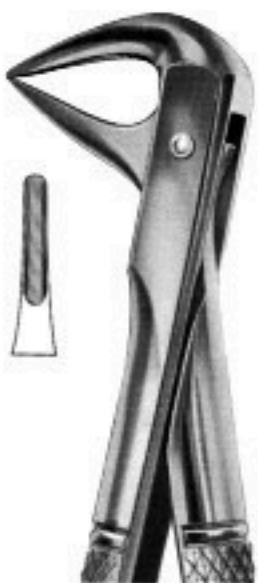

786-142
Fig. 74N
Lower roots



786-143
Fig. 75
Lower premolars
& canines



786-144
Fig. 76
Upper roots



786-145
Fig. 76N
Upper roots
(narrow beak)



EXTRACTING FORCEPS (English Pattern)

- Щипцы экстракционные (английская форма)
- Daviers (Forme Anglaise)
- Zahnzangen (Englische Form)

- Щипці екстракційні (англійська форма)
- Forceps de Extracción (Forme Inglesa)
- استخراج الملقط (تمط اللغة الإنجليزية)



786-146
Fig. 79
Lower wisdoms



786-147
Fig. 79A
Lower wisdoms



786-148
Fig. 86A
Lower molars



786-149
Fig. 86B
Lower molars



786-150
Fig. 86C
Lower molars



786-151
Fig. 87
Cowhorn beak



786-152
Fig. 89
Right upper molars



786-153
Fig. 90
Left upper molars



EXTRACTING FORCEPS (English Pattern)

- Щипцы экстракционные (английская форма)
- Daviers (Forme Anglaise)
- Zahnzangen (Englische Form)

- Щипці екстракційні (англійська форма)
- Forceps de Extracción (Forme Inglesa)
- استخراج الملقط (تمط اللغة الإنجليزية)



786-154
Fig. 94
Right upper molars

786-155
Fig. 95
Left upper molars

786-156
Fig. 99
Lower molars
(broken-down)

786-157
Fig. 99 1/4
Lower molars
(broken-down)

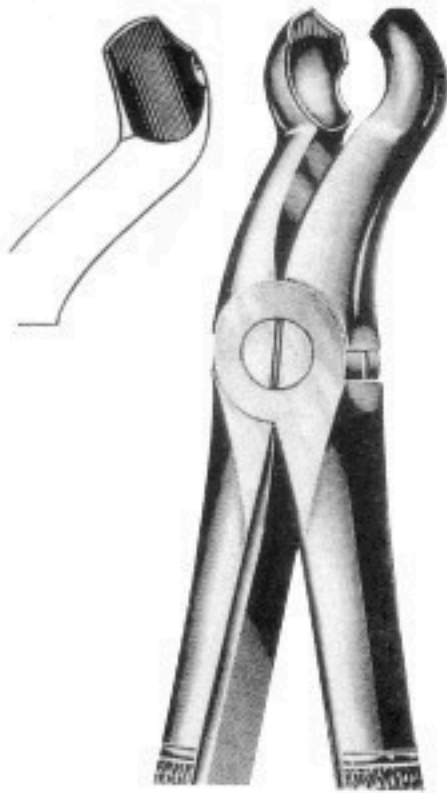

786-158
Fig. 121
Upper wisdoms



786-159
Fig. 136
Upper centrals
& roots

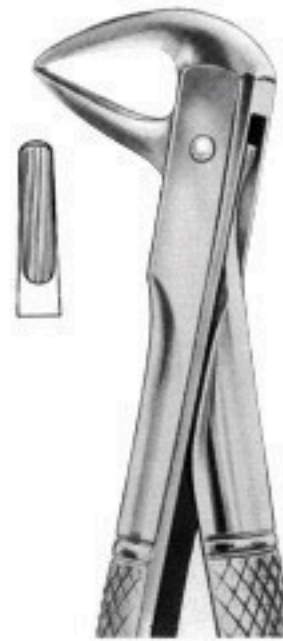

786-160
Fig. 137
Lower centrals
& roots

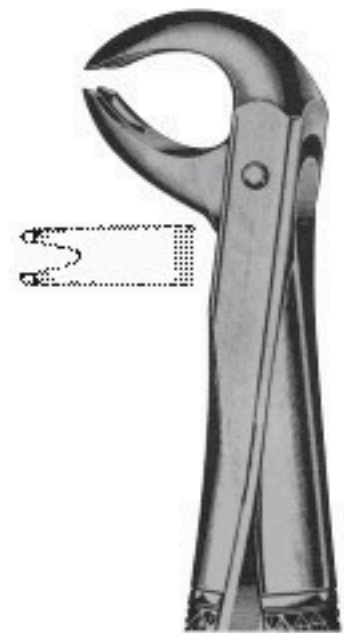

786-161
Fig. 167
Universal pincer
for lower teeth
molars & premolars



EXTRACTING FORCEPS (English Pattern)

- Щипцы экстракционные (английская форма)
- Daviers (Forme Anglaise)
- Zahnzangen (Englische Form)

- Щипці екстракційні (англійська форма)
- Forceps de Extracción (Forme Inglesa)
- استخراج الملقط (تمط اللغة الإنجليزية)

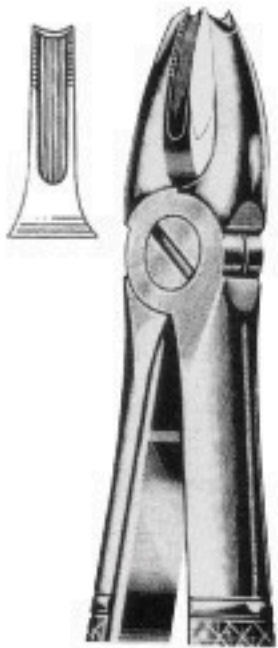

786-162
Fig. 168
Upper canines

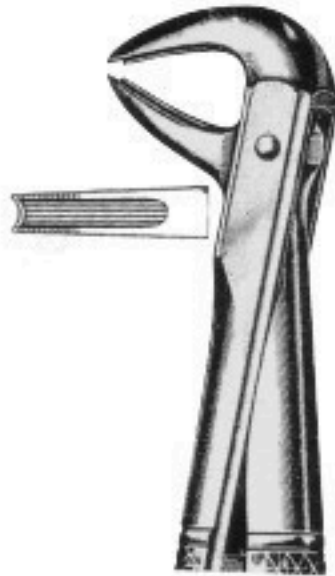

786-163
Fig. 169
Lower canines
& premolars



786-164
Fig. 233
Lower root
(parallel beaks)

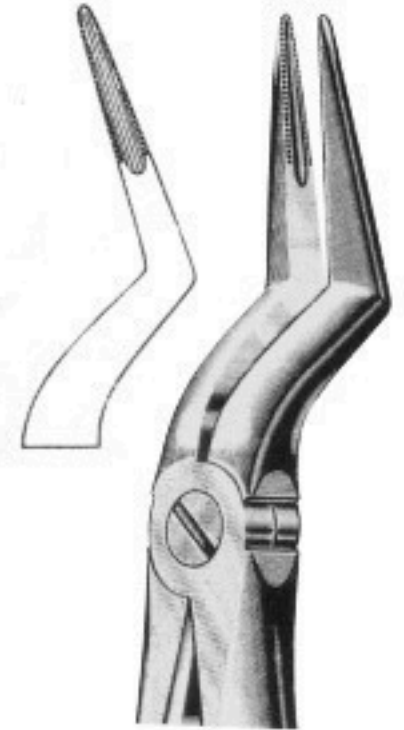

786-165
Fig. 235
Upper root
(parallel beaks)

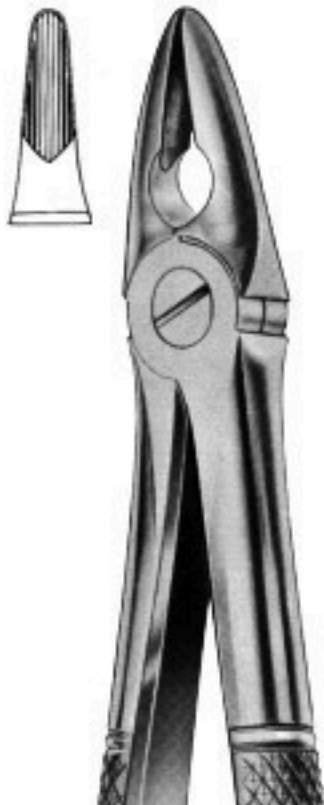

786-166
Fig. MD 1
universal forceps for upper
wisdoms, premolars & roots



786-167
Fig. MD 2
Upper Molars



786-168
Fig. MD 3
Lower roots

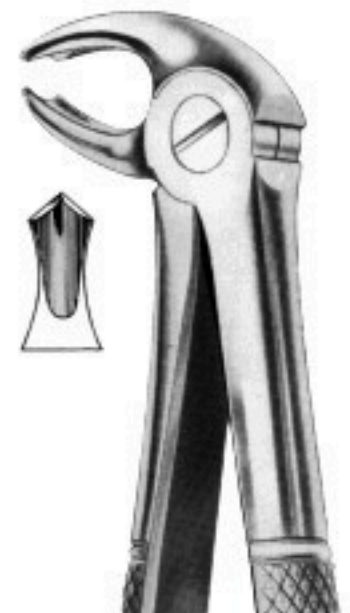

786-169
Fig. MD 4
Lower Molars



EXTRACTING FORCEPS (English Pattern)

- Щипцы экстракционные (английская форма)
- Daviers (Forme Anglaise)
- Zahnzangen (Englische Form)

- Щипці екстракційні (англійська форма)
- Forceps de Extracción (Forme Inglesa)
- استخراج الملقط (تمط اللغة الإنجليزية)

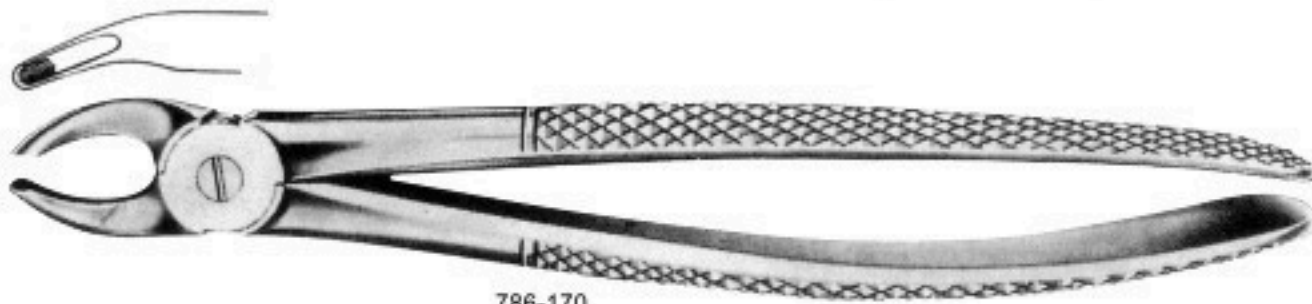

786-170
Fig. 158

Children's upper teeth molars universal

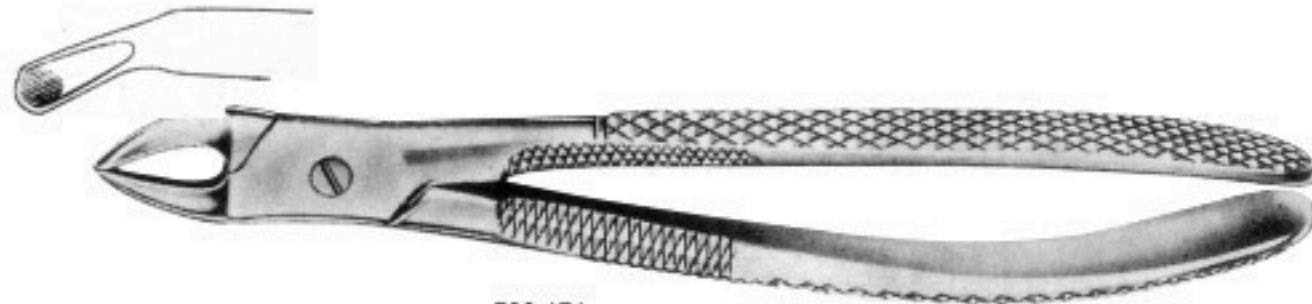

786-171
Fig. 159

Children's lower molars universal

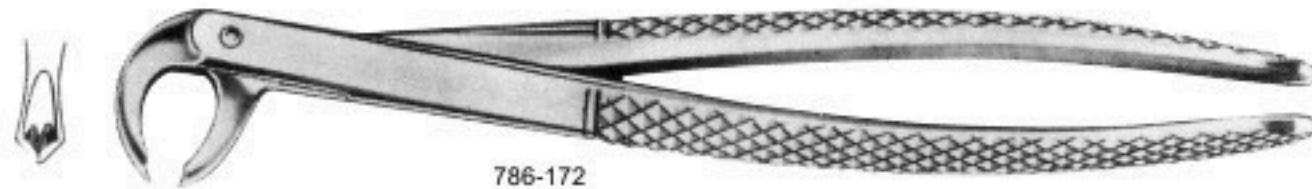

786-172
Fig. 160

Children's upper lower universal (hawk's bill)

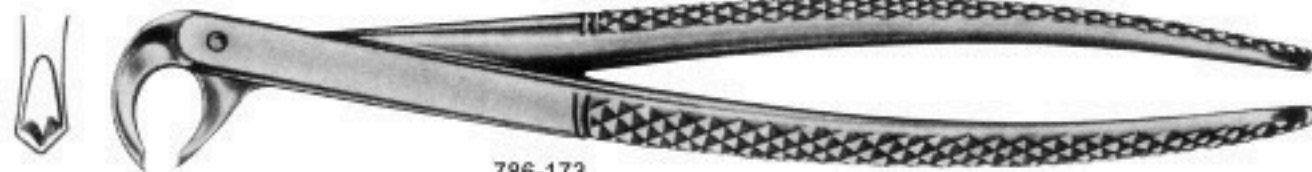

786-173
Fig. 161

Children's lower & roots

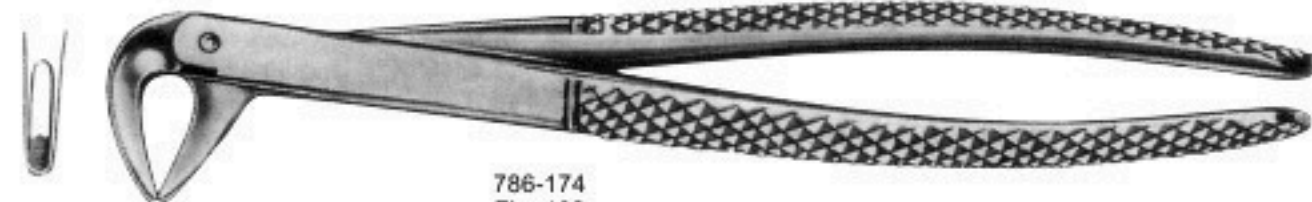

786-174
Fig. 162

Children's upper centrals



786-175
Fig. 163

Children's upper centrals



EXTRACTING FORCEPS (English Pattern)

- Щипцы экстракционные (английская форма)
- Daviers (Forme Anglaise)
- Zahnzangen (Englische Form)

- Щипці екстракційні (англійська форма)
- Forceps de Extracción (Forme Inglesa)
- استخراج الملقط (تمط اللغة الإنجليزية)

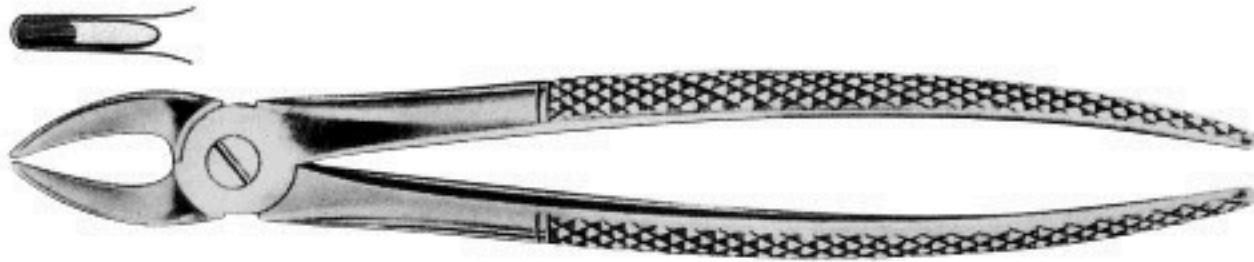

786-176
Fig. 37

Children's upper incisors & canines

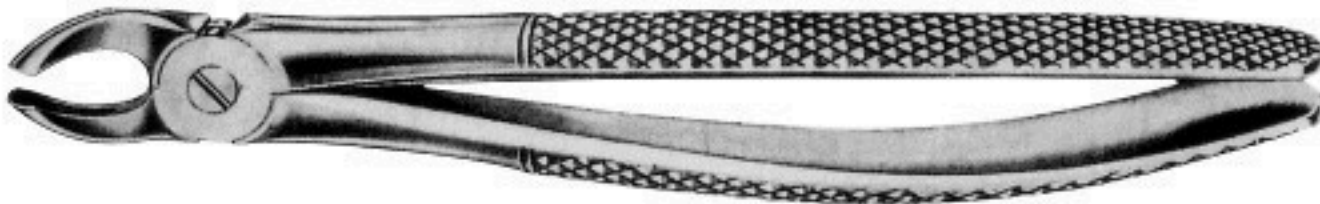

786-177
Fig. 39

Children's upper molars & universal

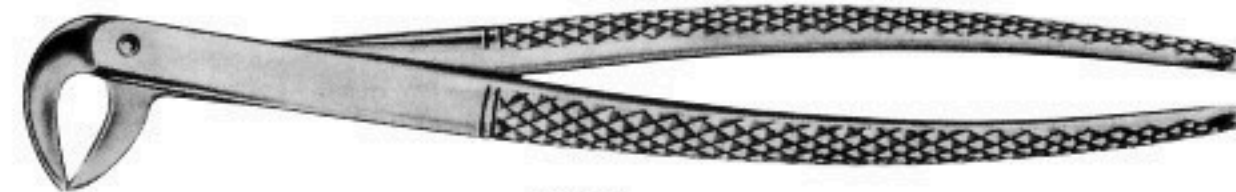

786-178
Fig. 123

Children's lower teeth universal

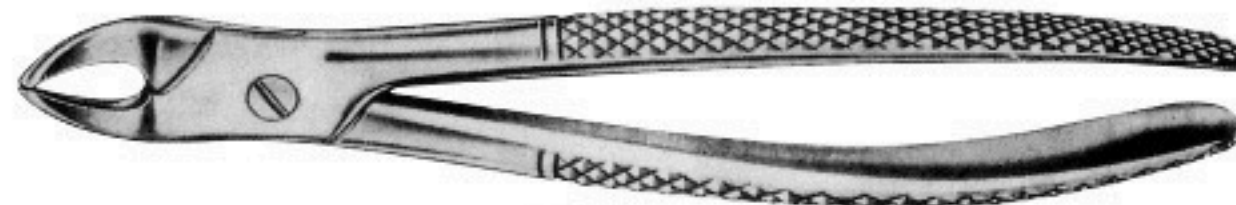

786-179
Fig. 138

Children's upper universal & roots

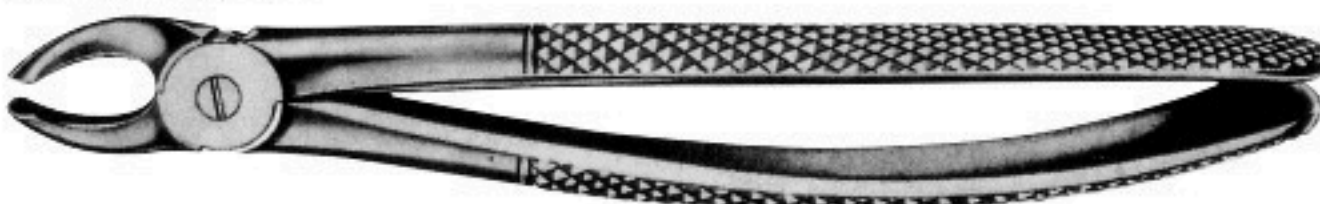

786-180
Fig. 157

Children's upper molars universal



WISDOM TEETH EXTRACTING FORCEPS, ROOT FRAGMENT FORCEPS

- Щипцы экстракционные для зубов мудрости(английская форма)
- Daviers (Forme Anglaise)
- Zahnzangen (Englische Form)
- Щипці екстракційні для зубів мудрості (англійська форма)
- Forceps de Extracción (Forme Inglesa)
- الحكمة استخراج الملقط



786-181
universal pattern for upper teeth



786-182
universal pattern for lower teeth



786-183
Fig. 22 1/2 L
Left lower wisdoms
& molars



786-184
Fig. 22 1/2 R
Right lower wisdoms
& molars



TOOTH EXTRACTING FORCEPS (For Children'S with Spring)

- Щипцы экстракционные детские
- Daviers - forme anglaise
- Pinzere per estrazione per bambini

- Щипці екстракційні дитячі
- Fórceps de extracci3n - forma inglesa
- استخراج الملقت (للأطفال)



786-185
Fig. 3
Upper molars



786-186
Fig. 5
Lower incisors



786-187
Fig. 6
Lower molars



786-188
Fig. 7
Lower roots



786-189
Fig. 137
Upper incisors
& canines



786-190
Fig. 139
Upper premolars



786-191
Fig. 51S
Upper roots



EXTRACTING FORCEPS (American Pattern)

- Щипцы экстракционные (американская форма)
- Daviers - forme américaine
- Fórceps de extracción - forma americana
- Щипці екстракційні (американська форма)
- Pinzere per estrazione - forma americana
- استخراج الملقط (النمط الأمريكي)



786-192
Fig. 1
Upper centrals,
laterals & cuspids



786-193
Fig. 5
Lower third molars



786-194
Fig. 6
Separating forceps

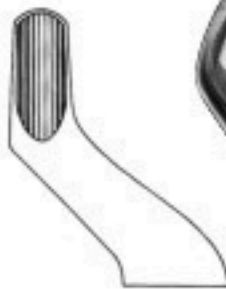

786-195
Fig. 10 H
Upper molars



786-196
Fig. 10S
Upper roots



786-197
Fig. 15
Lower molars



EXTRACTING FORCEPS (American Pattern)

- Щипцы экстракционные (американская форма)
- Daviers - forme américaine
- Fórceps de extracción - forma americana

- Щипці екстракційні (американська форма)
- Pinzere per estrazione - forma americana
- استخراج الملقط (النمط الأمريكي)



786-198
Fig. 16S
Lower molars children



786-199
Fig. 16
Lower molars
(cow-horn beak)

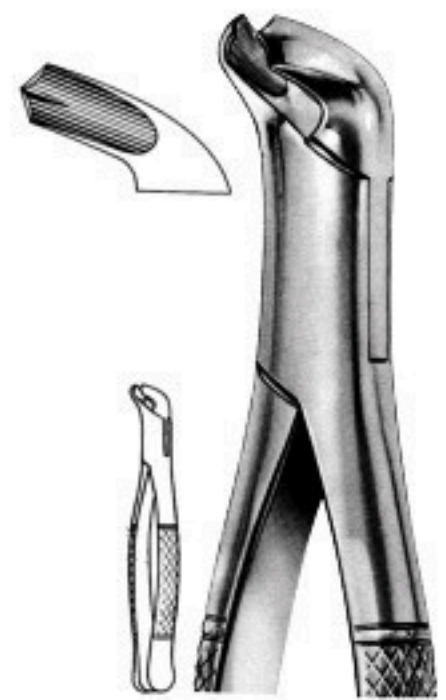

786-200
Fig. 17
Lower molars



786-201
Fig. 18 L
Upper molars
left side



786-202
Fig. 18R
Upper molars,
right side

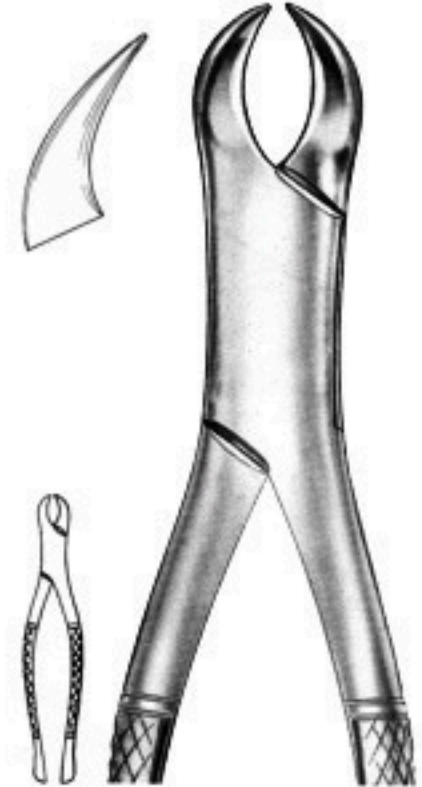

786-203
Fig. 23
Lower molars
(cow-horn beak)



EXTRACTING FORCEPS (American Pattern)

- Щипцы экстракционные (американская форма)
- Daviers - forme américaine
- Fórceps de extracción - forma americana

- Щипці екстракційні (американська форма)
- Pinzere per estrazione - forma americana
- استخراج الملقط (النمط الأمريكي)



786-204
Fig. 32
Upper molars &
premolars
strong beak



786-205
Fig. 53 L
upper molars
Left side



786-206
Fig. 53 R
Upper molars
right side



786-207
Fig. 62
Universal forceps
for upper teeth & roots



786-208
Fig. 65
Upper incisors & roots



786-209
Fig. 69
Fragments & small roots
Upper & Lower



EXTRACTING FORCEPS (American Pattern)

- Щипцы экстракционные (американская форма)
- Daviers - forme américaine
- Fórceps de extracción - forma americana
- Щипці екстракційні (американська форма)
- Pinzere per estrazione - forma americana
- استخراج الملقط (النمط الأمريكي)

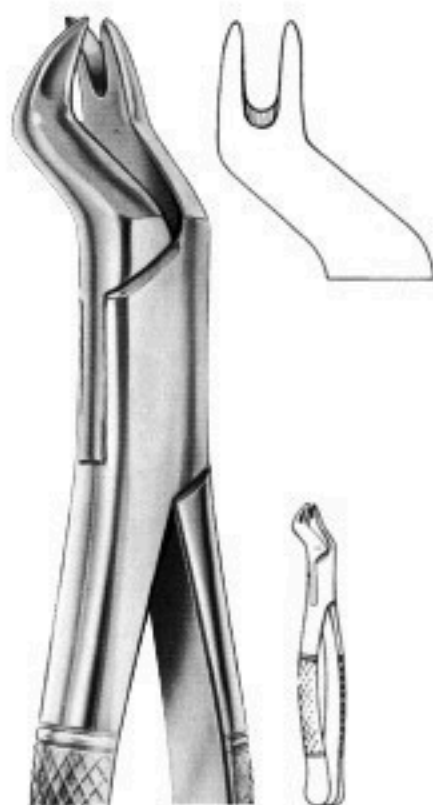

786-210
Fig. 88R
Right upper molars



786-211
Fig. 88L
Left upper molars



786-212
Fig. 99C
Upper premolars
molar & incisors



786-213
Fig. 101
Universal forceps
for premolars



786-214
Fig. 150
Upper premolars,
incisors & roots



786-215
Fig. 150A
Upper premolars,
incisors & roots



786-216
Fig. 150S
Upper premolars,
incisors & roots
for children



EXTRACTING FORCEPS (American Pattern)

- Щипцы экстракционные (американская форма)
- Daviers - forme américaine
- Fórceps de extracción - forma americana

- Щипці екстракційні (американська форма)
- Pinzere per estrazione - forma americana
- استخراج الملقط (النمط الأمريكي)



786-217
Fig. 151
Lower premolars,
incisors & roots

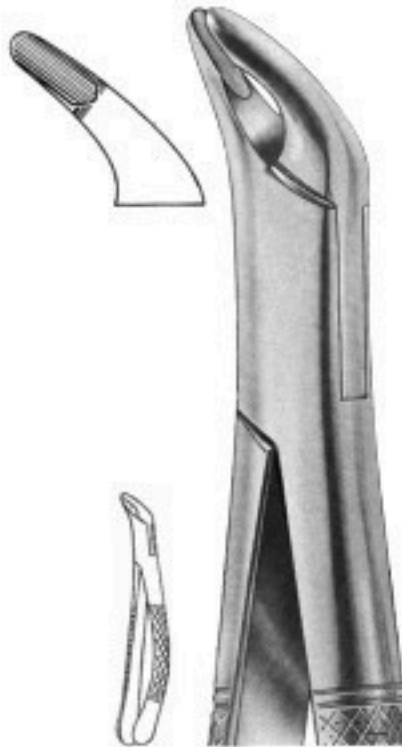

786-218
Fig. 151A
Lower premolars,
incisors & roots



786-219
Fig. 151 S
Lower premolars, incisors & roots
for children



786-220
Fig. 210H
Upper wisdoms
with hook handle



786-221
Fig. 210S
Upper wisdoms
with stragith handle

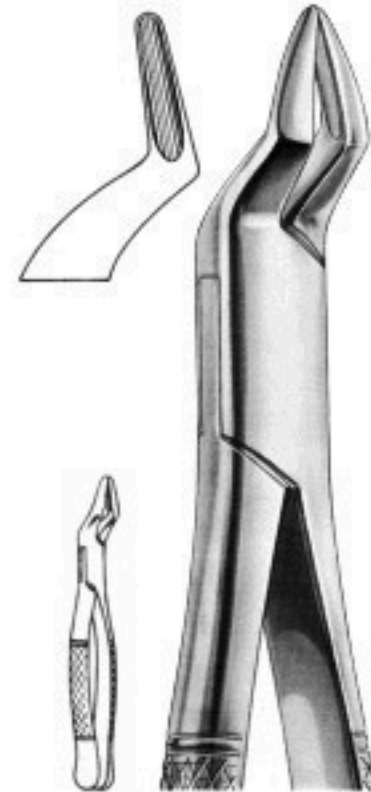

786-222
Fig. 222
Lower wisdoms

786-223
Fig. 286
Upper roots, premolars & incisors



ROOTS SPLINTER FORCEPS, EXTRACTION TWEEZER

- Щипцы для удаления корневых осколков
- Pincers Fragments
- Wurzelsplitterzangen

- Щипці для видалення корневих осколків
- Pinzas Para Fragmentos
- جذور منشقة الملقط



786-224
Fig. 1
Lower roots



786-225
Fig. 2
Upper roots



786-228
Fig. 1
Root Fragments



786-226
Albrecht
16 cm



786-227
Albrecht
16 cm



786-229
Fig. 2
Root Fragments



BONE RONGEURS

- Костные кусачки
- Hohlmeißelzangen
- Pincés-gouges

- Кусачки для кісток
- Pinzas-gubias
- رونجیورس العظام



786-230
Blumenthal
15 cm



786-231
Blumenthal 45°
14.5 cm



786-232
Blumenthal 90°
14 cm

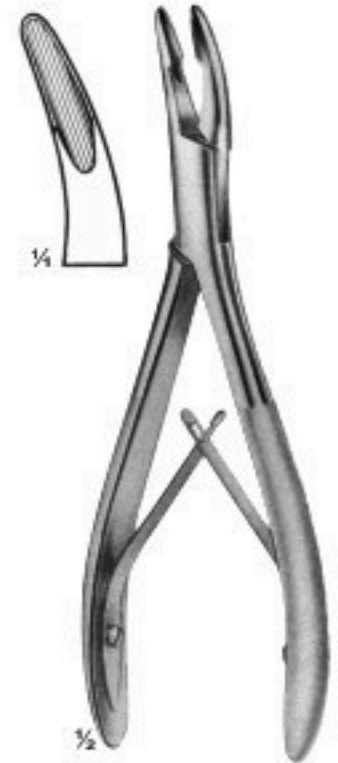

786-233
Mead 1A
16.5 cm



786-234
Beyer
18 cm



786-235
Ruskin - mini
15.5cm

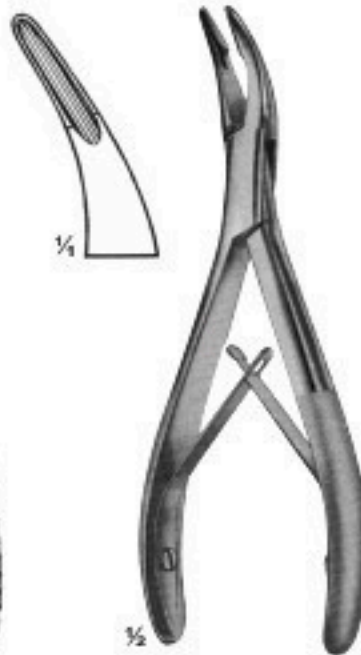

786-236
Luer
15 cm



786-237
Friedman
14 cm



786-238
Mini Friedman
12 cm

Multiple Action



ROOT ELEVATORS

- Элеватор корневой экстракционный
- Elévateurs à racines
- Wurzelheber

- Єлеватор кореневий екстракційний
- Elevadores para raices
- المصاعد الجذر



786-239
Fig. 1B
Bein

3 mm

4 mm

3 mm

4 mm

3.2 mm

3.8 mm



786-240
Fig. 2B
Bein



786-241
Fig. 3B
Bein



786-242
Fig. 4B
Bein



786-243
Fig. 5B
Bein



786-244
Fig. 6B
Bein



786-245
Fig. 4 SA
Schmeckeblat
Apexo
Flat tip



786-246
Fig. 5 SA
Schmeckeblat
Apexo
Flat tip



786-247
Fig. 34 S
Seldin



786-248
Fig. 34
Seldin



786-249
Fig. 2S
Seldin



786-250
3S
Seldin

3 mm



786-251
Fig. 1F
Flohr



786-252
Fig. 2F
Flohr

3.5 mm



786-253
Fig. 3F
Flohr



ROOT ELEVATORS

- Элеватор корневой экстракционный
- *Elévateurs à racines*
- Wurzelheber

- Єлеватор кореневий екстракційний
- Elevadores para raices
- المصاعد الجذر



786-254
Fig. 71
Miller-Apexo



786-255
Fig. 72
Miller-Apexo



786-256
Fig. 73
Miller-Apexo



786-257
Fig. 74
Miller-Apexo



786-258
Fig. 19



786-259
Fig. 20



786-260
Fig. 51
Curtis



786-261
Fig. 52
Curtis



786-262
Fig. 1 L
Seldin



786-263
Fig. 1 R
Seldin



786-264
Fig. 4 L
Seldin



786-265
Fig. 4 LR
Seldin



786-266
Fig. 11
Stout



786-267
Fig. 11A
Stout



786-268
Fig. 44C
Stout



ROOT ELEVATORS

- Элеватор корневой экстракционный
- Elévateurs à racines
- Wurzelheber

- Єлеватор кореневий екстракційний
- Elevadores para raices
- المصاعد الجذر



786-269
Fig. A
Cogswell



786-270
Fig. B
Cogswell



786-271
Fig. 301
Apexo



786-272
Fig. 302
Apexo



786-273
Fig. 303
Apexo



786-274
Fig. 301W
Seldin



786-275
Fig. 304W
Seldin



786-276
Fig. 1H
Heidbrink



786-277
Fig. 2H
Heidbrink



786-278
Fig. 40H
Heidbrink



786-279
Fig. 41H
Heidbrink



786-280
Fig. 46



786-281
Fig. 46R



ROOT ELEVATORS

- Элеватор корневой экстракционный
- Elévateurs à racines
- Wurzelheber

- Єлеватор кореневий екстракційний
- Elevadores para raices
- المصاعد الجذر



786-282
Fig. 44
Cryer



786-283
Fig. 45
Cryer



786-284
Fig. 25
Cryer



786-285
Fig. 26
Cryer



786-286
Fig. 31
Cryer



786-287
Fig. 32
Cryer



786-288
Fig. 80



786-289
Fig. 81



786-290
Fig. 81A



786-291
Fig. 81E



786-292
Fig. 190



786-293
Fig. 191



786-294
Fig. 23



786-295
Fig. 24



786-296
Fig. 98



ROOT ELEVATORS

- Элеватор корневой экстракционный
- Elévateurs à racines
- Wurzelheber

- Єлеватор кореневий екстракційний
- Elevadores para raices
- المصاعد الجذر



786-297
Fig. A1C
Coupland



786-298
Fig. A2C
Coupland



786-299
Fig. A3C
Coupland



786-300
Fig. 15
Woodward



786-301
Fig. 16
Woodward



786-302
Fig. 1C
Coupland



786-303
Fig. 2C
Coupland



786-304
Fig. 3C
Coupland



786-305
Fig. 11M



786-306
Fig. 12M



786-307
Fig. 13M

Mac millan



786-308
Fig. 8



786-309
Fig. 21
University of
michigan



786-310
Fig. 69W
Woodward



786-311
Fig. 31F
Friedman



786-312
Fig. 32F
Friedman



ROOT ELEVATORS

- Элеватор корневой экстракционный
- *Elévateurs à racines*
- Wurzelheber

- Єлеватор кореневий екстракційний
- Elevadores para raices
- المصاعد الجذر



786-313
Fig. 1
Bein



786-314
Fig. 2
Bein



786-315
Fig. 3
Bein



786-316
Fig. 4
Bein



786-317
Fig. 5
Bein



786-318
Fig. 6
Bein



786-319
Fig. 1



786-320
Fig. 2



786-321
Fig. 2
Flohr



786-322
Fig. 3
Flohr



786-323
Fig. 3
Cryer



786-324
Fig. 8
Cryer



ROOT ELEVATORS

- Элеватор корневой экстракционный
- Elévateurs à racines
- Wurzelheber

- Єлеватор кореневий екстракційний
- Elevadores para raices
- المصاعد الجذر



786-325
Fig. 1
Heidbrink



786-326
Walter F. Barry



786-327
Fig. 320



786-328
Fig. 321



786-329
Fig. 322



786-330
Fig. 323

Walter F. Barry



786-331
Fig. 2
Heidbrink



786-332
Fig. 3
Heidbrink



786-339
Fig. 2
Warwick-James



786-340
Fig. 3
Warwick-James



786-333
Winter



786-334
Fig. 11LW

786-335
Fig. 11RW

786-336
Fig. 12LW

786-337
Fig. 12RW



786-338
Fig. 1
Warwick-James



PLIERS FOR ORTHODONTICS & PROSTHETICS

- Щипцы для ортодонтии и протезирования
- Pincers pour l'orthodontie et la prothèse
- Zangen für Kieferorthopädie und Prothetik

- Щипці для ортодонтії та протезування
- Alicates para ortodoncia y prótesis
- كماشة لتقويم الأسنان برومشتيس



786-341
waldsachs
15 cm



786-342
Universal
16 cm



786-343
Nance
13,5 cm



786-344
Aderer
14,5 cm



786-345
Modell Marburg
Serrated Jaws
14 cm



786-346
Modell Marburg
Smooth Jaws
14 cm



786-347
Modell Marburg
Carbid Inserts Jaws
14 cm



786-348
Goslee
One Serrated Jaws
14 cm



PLIERS FOR ORTHODONTICS & PROSTHETICS

- Щипцы для ортодонтии и протезирования
- Pincers pour l'orthodontie et la prothèse
- Zangen für Kieferorthopädie und Prothetik

- Щипці для ортодонтії та протезування
- Alicates para ortodoncia y prótesis
- كامشة لتقويم الأسنان برومشتيس



786-349
14cm



786-350
14cm



786-351
14cm



786-352
14cm



786-353
14cm



786-354
14cm



786-355
14cm



786-356
14cm



786-357
Serrated Jaws
12cm



786-358
How
14,5 cm



786-359
How-angled
14,5 cm



786-360
Arrow clasp forming
12 cm



786-361
Arrow clasp forming
12 cm



786-362
Arrow clasp forming
12 cm



PLIERS FOR ORTHODONTICS & PROSTHETICS

- Щипцы для ортодонтии и протезирования
- Pincers pour l'orthodontie et la prothèse
- Zangen für Kieferorthopädie und Prothetik

- Щипці для ортодонтії та протезування
- Alicates para ortodoncia y prótesis
- كامشة لتقويم الأسنان برومشتيس



786-363
Peeso
13,5 cm

for wire up to



786-370
Andresen
13 cm



786-364
Peeso
13,5 cm

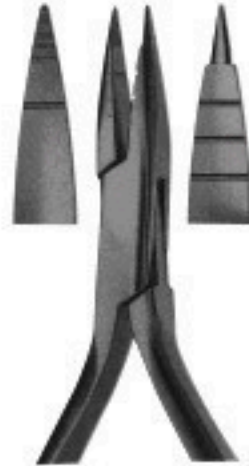

786-367
14 cm

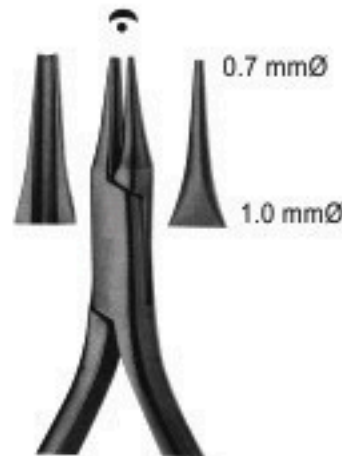

786-371
13,5 cm



786-365
14 cm



786-368
13 cm



786-372
Schwarz
13,5 cm

Round Nose Pliers



786-366
Langenbeck
14 cm



786-369
Angle
12,5 cm



786-373
Fischer
13 cm



PLIERS FOR ORTHODONTICS & PROSTHETICS

- Щипцы для ортодонтии и протезирования
- Pincers pour l'orthodontie et la prothèse
- Zangen für Kieferorthopädie und Prothetik

- Щипці для ортодонції та протезування
- Alicates para ortodoncia y prótesis
- كماشة لتقويم الأسنان برومشتيتيس



786-374
Aderer
12 cm



786-375
Aderer-Heavy
12 cm



786-376
Tweed
14,5 cm



786-377
O'Brien
13,5 cm



786-378
Wire Bending Pliers
12,5 cm



786-379
Adams
12,5 cm



786-381
Young
14 cm



786-380
Frevert
12,5 cm



786-382
Clasp forming
14 cm



ORTHODONTICS INSTRUMENTS

- Инструменты ортодонтические
- Instrumentos Ortodonticos
- Orthodontische Instrumente

- Інструменти ортодонтичні
- Instruments Orthodontiques
- أدوات تقويم الأسنان

Ligature instruments



786-383
Band seating &
removing instruments

786-384

786-385



786-386
Elastic instruments



786-387
Mershon Band Pusher
14 cm



786-388
Band setter with
tin insert
15 cm



786-389
13,5 cm



786-390
14 cm

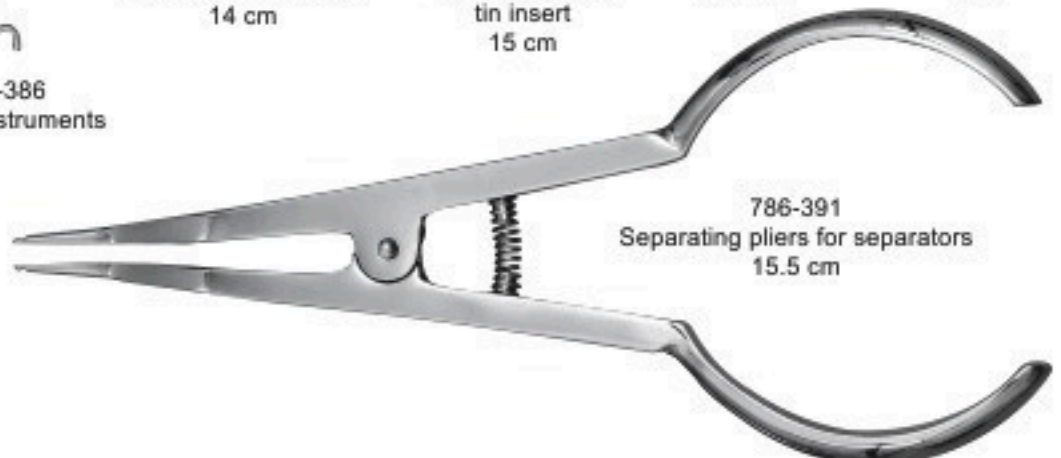

786-391
Separating pliers for separators
15.5 cm



ORTHODONTICS INSTRUMENTS

- Инструменты ортодонтические
- Instrumentos Ortodonticos
- Orthodontische Instrumente

- Інструменти ортодонтичні
- Instruments Orthodontiques
- أدوات تقويم الأسنان



786-392
Mathieu Pliers
14 cm



786-393
Elastic Ligature Placing Pliers
14 cm



786-394
Mathieu Ligature Pliers
14 cm



786-395
Mathieu Pliers
with finger ring
14 cm



786-396
Mosquito Pliers



786-397
Bracket Positioning Gauge



786-398
Mosquito Pliers



786-399
Bracket Placing
Tweezer



786-400
Ligature Tying Plier



786-401
Bracket Holding
Tweezer



786-402
Band seating
instrument
nylon



786-403
Mosquito Forceps



GUM SCISSORS

- Ножницы десневые
- Ciseaux a gencives
- Zahnfleischscheren

- Ножиці для ясен
- Tijeras para encias
- مقص صمغ



786-404
Fig. 1
12 cm straight

786-405
Fig. 2
12 cm Curved



786-406
Fig. 1
13 cm
Goldman-Fox
Saw edge
Straight

786-407
Fig. 2
13 cm
Goldman-Fox
Saw edge
Curved



786-408
Fig. 1
11.5 cm
Iris
Straight

786-409
Fig. 2
11.5 cm
Iris
Curved

786-410
Fig. 3
11.5 cm
Iris



786-411
Fig. 1
11.5 cm
Angular, Saw edge

786-412
Fig. 2
11.5 cm
Angular



GUM SCISSORS

- Ножницы десневые
- Ciseaux a gencives
- Zahnfleischscheren

- Ножиці для ясен
- Tijeras para encias
- مقص صمغ

curved, saw edge



786-413
Fig. 1
La Grange
10,5 cm

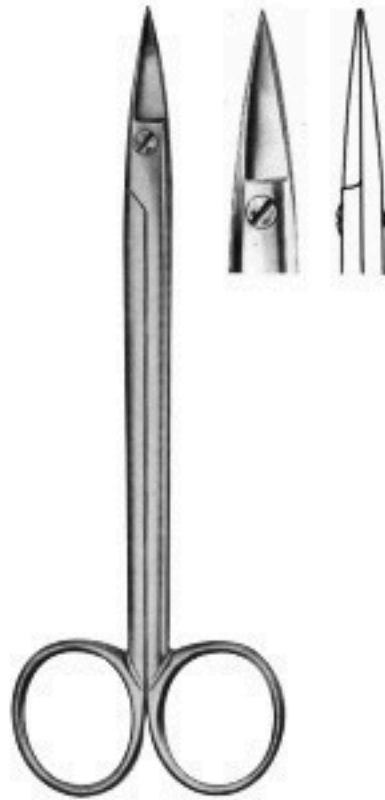

786-414
Fig. 1
Quinby
12,5 cm

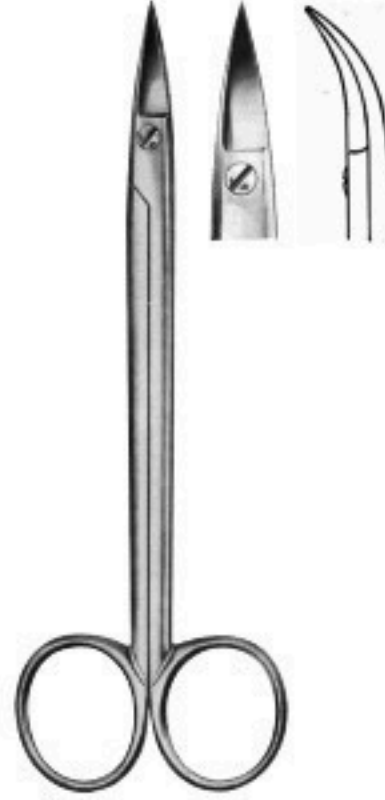

786-415
Fig. 2
Quinby
12,5 cm

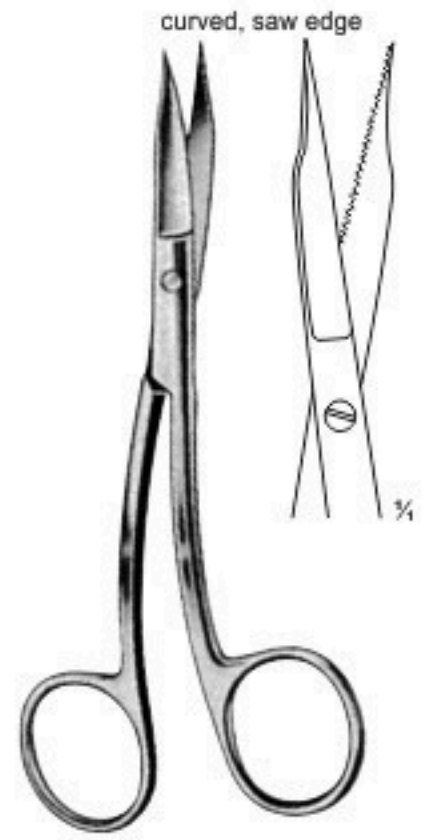

786-416
Fig. 3
Goldman-Fox (Special)
13 cm



786-417
Fig. 1
Kelly
16 cm

Straight



786-418
Fig. 2
Kelly
16 cm
Curved



786-419
Fig. 1
Locklin
16,5 cm

saw edge



786-420
Fig. 2
Locklin
16,5 cm

saw edge



SURGICAL SCISSORS

- хірургічні ножиці
- Ciseaux chirurgicaux
- Tijeras quirúrgicas

- Хирургические ножницы
- Forbici chirurgiche
- مقص جراحي



786-421
Fig. 1
Noyes (Castroviejo)
12 cm



786-422
Fig. 1
14,5 cm



786-423
Fig. 1
westcott
11 cm



786-424
Fig. 2
westcott
11 cm



786-425
Fig. 1
Spencer
9 cm



786-426
Fig. 2
Spencer
13 cm



786-427
Fig. 1
Neumann
12,5 cm

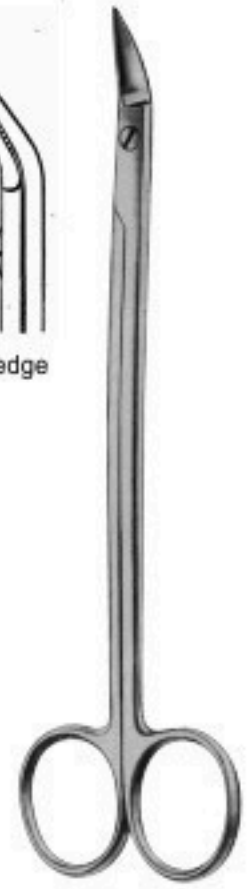

786-428
Fig. 1
Dean
17 cm



GUM SCISSORS

- Ножницы десневые
- Ciseaux a gencives
- Zahnfleischscheren

- Ножиці для ясен
- Tijeras para encias
- مقص صمغ



Straight

786-429
Fig. 1
14,5 cm



Curved

786-430
Fig. 2
mayo
14,5 cm,



786-431
Fig. 1
Metzenbum
14,5 cm



786-432
Fig. 2
Metzenbum
14,5 cm



786-433
Fig. 1
Metzenbum-Delicate
14,5 cm



786-434
Fig. 2
Metzenbum-Delicate
14,5 cm



HAEMOSTATIC FORCEPS

- Зажимы артериальные
- Pincers hemostatiques
- Arterienklemmen

- Затискачі артеріальні
- Pinzas hemostaticas
- ملقط هایموستاتیک

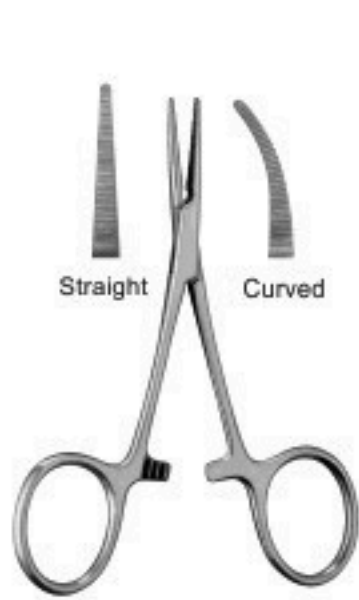

786-435
Baby-Mosquito
10 cm

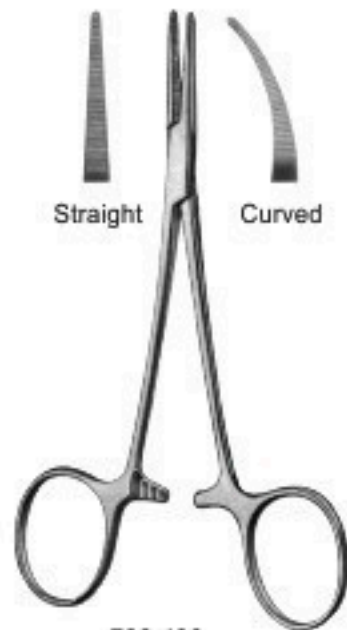

786-436
Halsted-Mosquito
12,5 cm

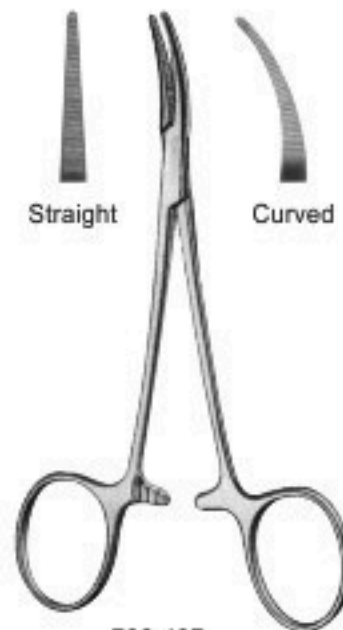

786-437
Halsted-Mosquito
12,5 cm

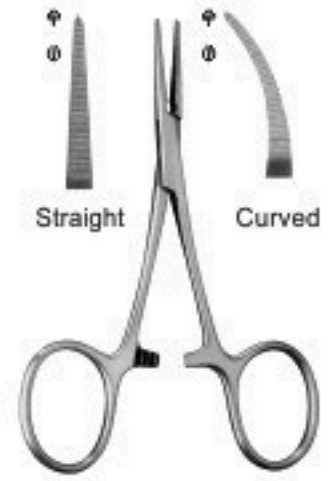

786-438
Baby-Mosquito
10 cm

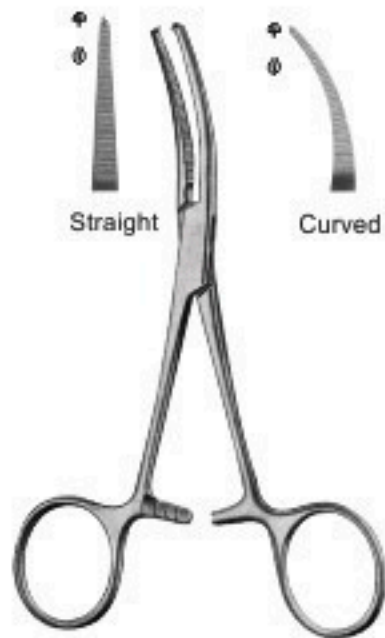

786-439
Micro-Halsted
12,5 cm

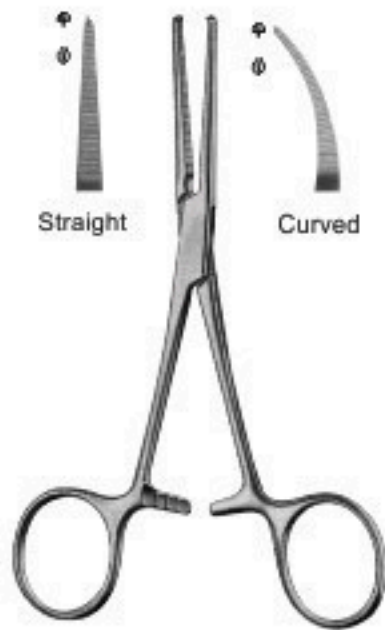

786-440
Halsted-Mosquito
12,5 cm



786-441
Pean
12,5 cm, 5"

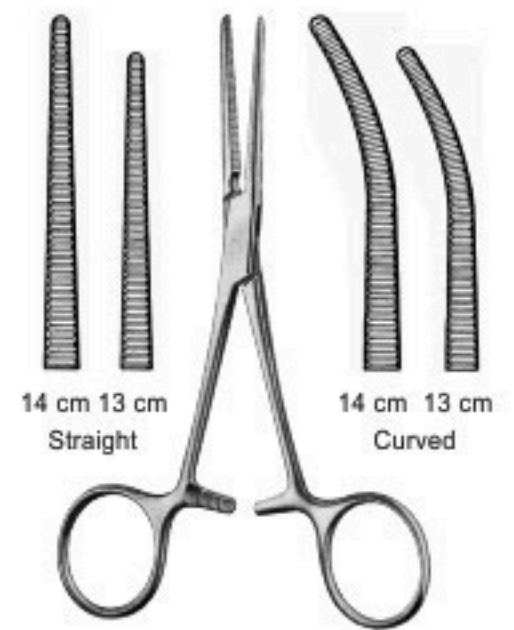

786-442
Pean
13 cm



HAEMOSTATIC FORCEPS

- Зажимы артериальные
- Pinces hemostatiques
- Arterienklemmen

- Затискачі артеріальні
- Pinzas hemostaticas
- ملقط هایموستاتیک

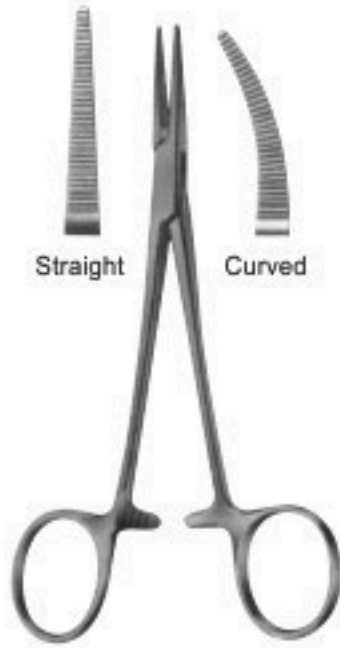

786-443
Baby-Crile (Pean)
14 cm

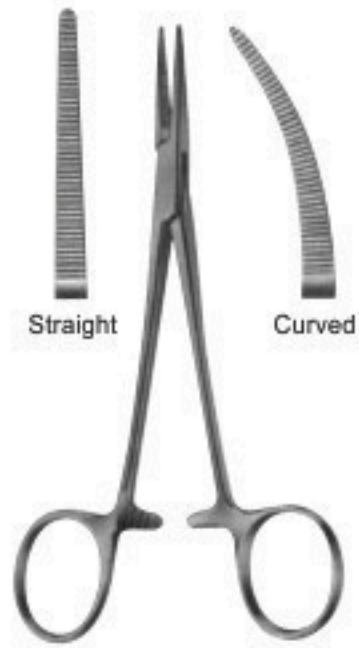

786-444
Crile
14 cm

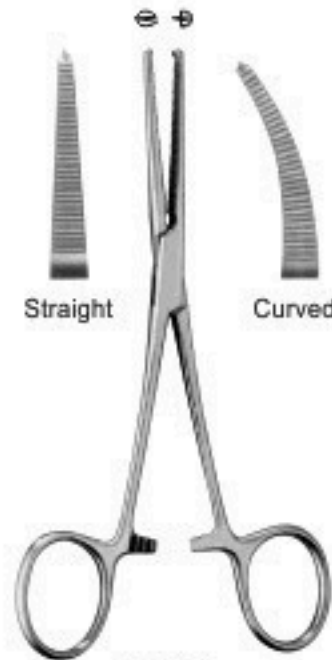

786-445
Baby-Crile (Kocher)
14 cm

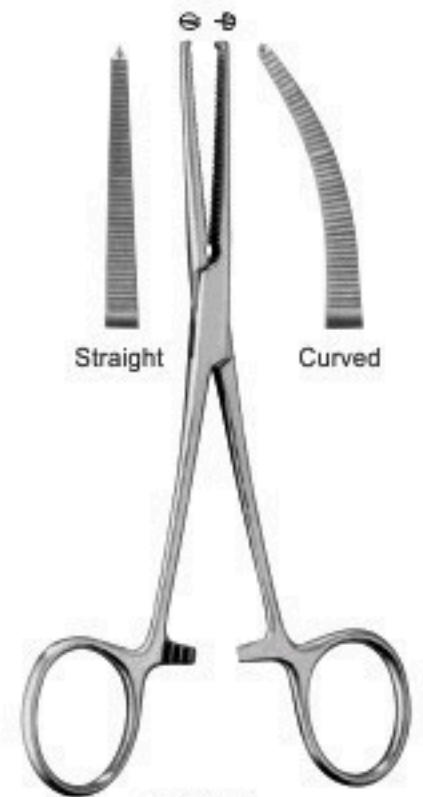

786-446
Crile (Kocher)
16 cm

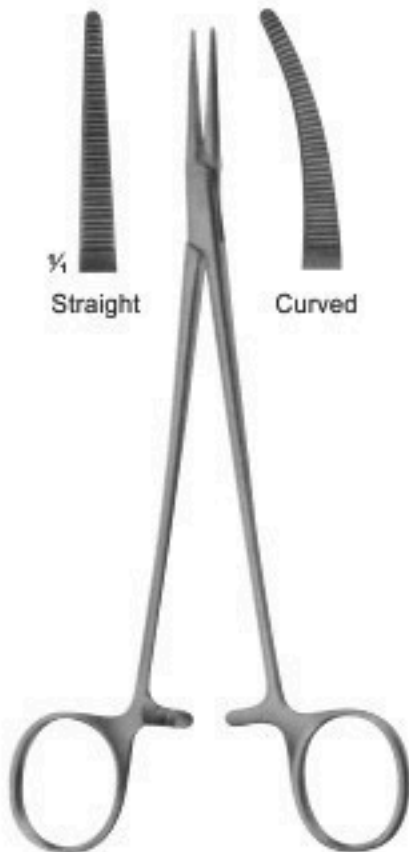

786-447
Halsted
18,5 cm

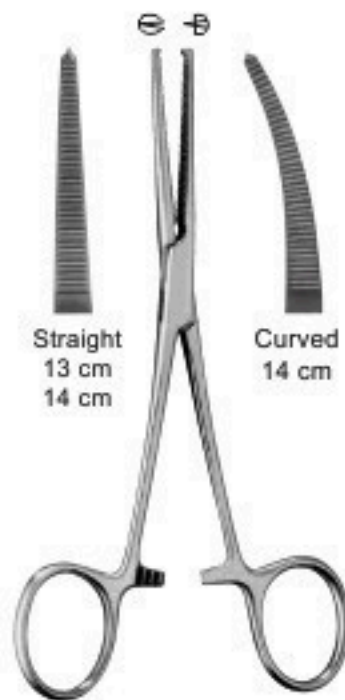

786-448
Kocher

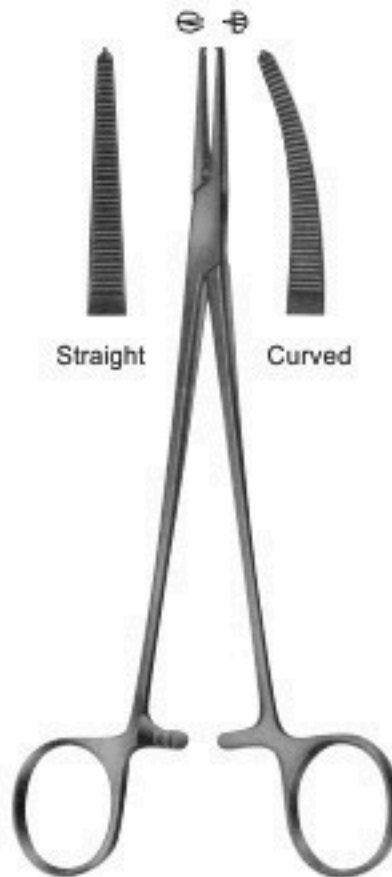

786-449
Halsted
18,5 cm



786-450
Baby-Mixer
18 cm



SPONGE AND DRESSING FORCEPS

- Зажим для наложения повязок
- Pincas a ponsements
- Kornzangen

- Зажим для накладення пов'язок
- Pinzas para curaciones
- خلع الملابس ملقط



786-451
without Ratchet
14,5 cm



786-452
with Ratchet
14,5 cm



786-453
Curved
17,5 cm



786-454
Curved
21 cm

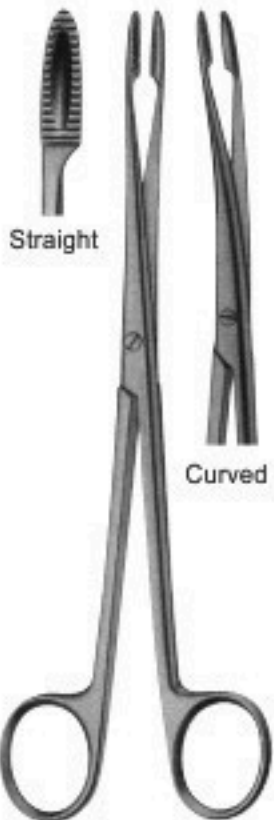

786-455
without Ratchet
18 cm

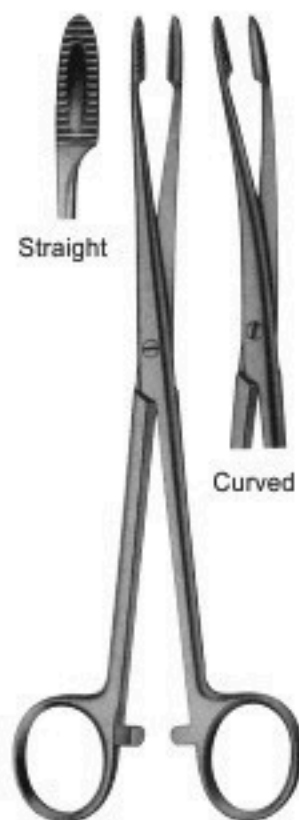

786-456
with Ratchet
18 cm

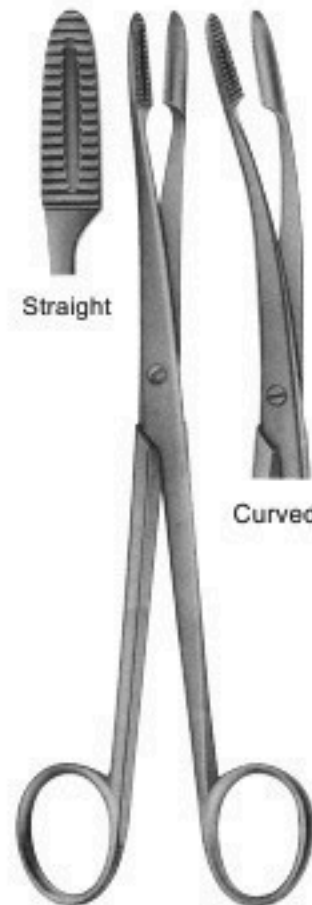

786-457
without Ratchet
20 cm

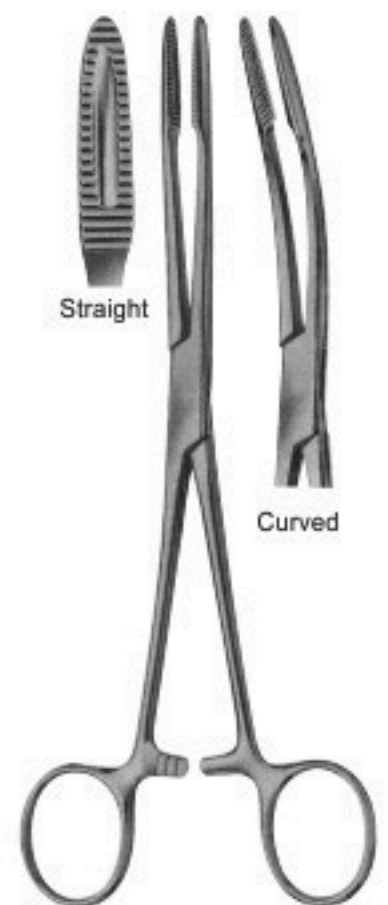

786-458
with Ratchet
20 cm



NEEDLE HOLDERS

- Иглодержатели
- Porte-aiguilles
- Nadelhalter

- Голкотримачі
- Porta-agujas
- أصحاب إبرة



786-459
Baumgartner
14,5 cm

Designed for Frontal & Palate Suture



786-460
Crile-Murray
15 cm

Needle Holder with scissors



786-461
Mayo-Hegar

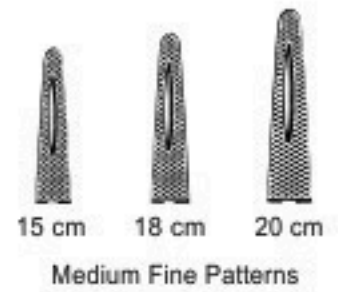

786-462
Adson
17,5 cm



786-463
Heger-Olson
14 cm



786-464
Gillies
15 cm

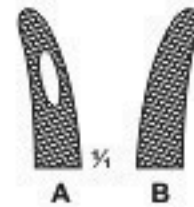



NEEDLE HOLDERS

- Иглодержатели
- Porte-aiguilles
- Nadelhalter

- Голкотримачи
- Porta-agujas
- أصحاب إبرة



786-465
Mathieu
14 cm



786-466
Mathieu
14 cm



786-467
Boynton
12 cm



786-468
Castroviejo
14 cm



786-469
Castroviejo
14 cm



786-470
Castroviejo
13 cm



786-471
Arruga
16 cm



TOWEL CLAMPS STERILIZING FORCEPS FOR STERILE INSTRUMENTS

- Рушник Затискачі стерилізації Пінцет для стерильних інструментів
- Полотенце Зажимы стерилизации Пинцет для стерильных инструментов
- Pincettes serviettes de stérilisation pour les instruments stériles Forceps
- Pinze Asciugamano sterilizzazione Pinze Per strumenti sterili
- Pinzas toalla esterilización Pinzas para los instrumentos estériles
- المشابك منشفة الملقط تعقيم للأدوات المعقمة

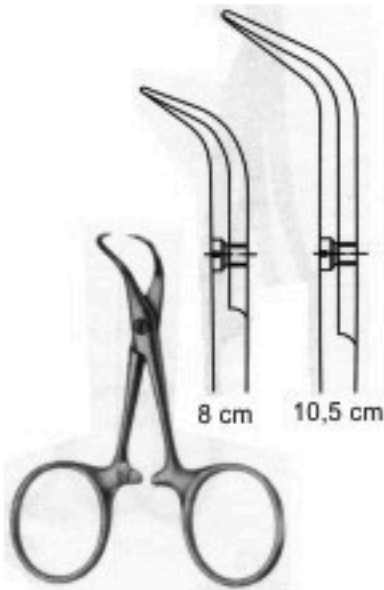

786-472
Backhaus



786-473
Backhaus

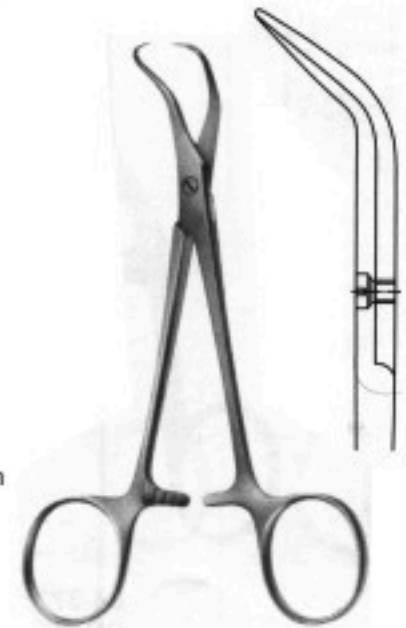

786-474
Backhaus-Kocher
13,5 cm



786-475
16 cm

786-476
Cheattle
28 cm



786-477
20 cm



786-478
20 cm, 8"
30 cm, 12"



786-479
Rogge
23,5 cm



SKIN HOOK & RETRACTORS

- Крюк шкіри та ретрактори
- crochet & rétracteurs peau
- Piel Hook & Retractoires
- Крюк кожи и ретракторы
- Hook & Divaricatori Pelle
- الكامشات هوك الجلد



786-480
Frazier
13 cm



786-481
Gillies
18 cm



786-484
Greefe
12,5 cm



786-487
Kilner
16 cm



786-488
Joseph
16,5 cm



786-489

786-490
3 mm

786-491
6 mm

786-492
8 mm



786-493
Bergmann
14 cm



786-494
Freer
15 cm

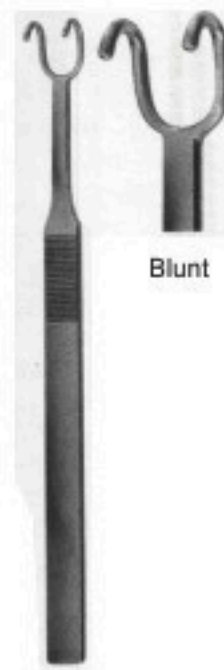

786-495
Fomon
14,5 cm

Blunt

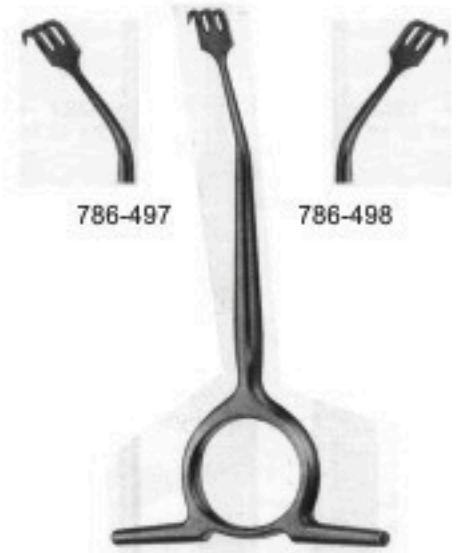

786-496
Williger
12 cm

786-497

786-498



RETRACTORS

- Ранорасширители
- Ecarteurs
- Wundhaken

- Ранорозширювачі
- Separadores
- الكامشات

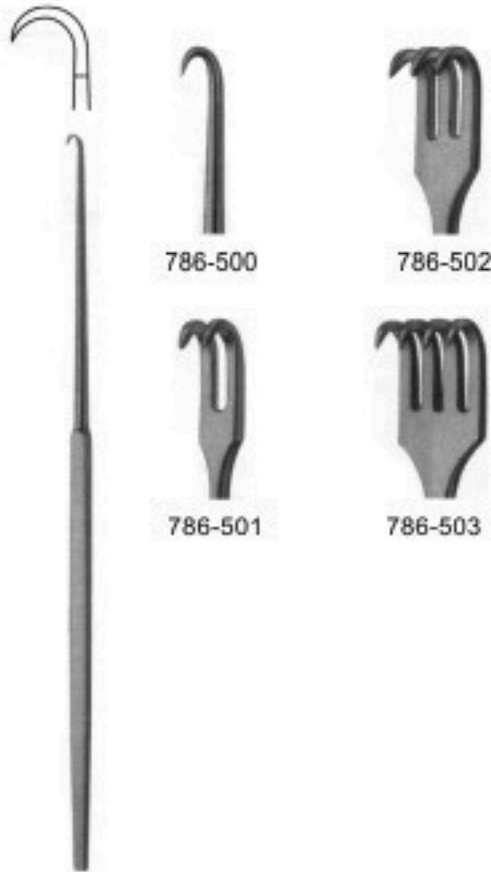

786-499
Small Curve, Sharp
16,5 cm

786-500



786-501



786-502



786-503

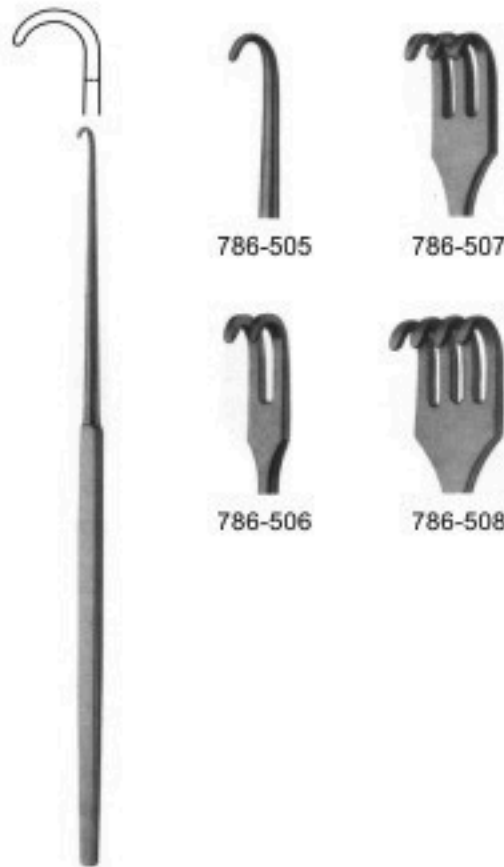

786-504
Small Curve, Blunt
16,5 cm

786-505



786-506



786-507



786-508



786-509
Flexible Shaft, Sharp
15,5 cm

786-510



786-511



786-512
Strandell-Stille
18 cm

786-513
Blunt

786-514
16 cm



786-515
16 cm

786-516

786-517



786-518
Langenbeck Green
16 cm

786-519
16 x 6 mm

786-520
25 x 6 mm

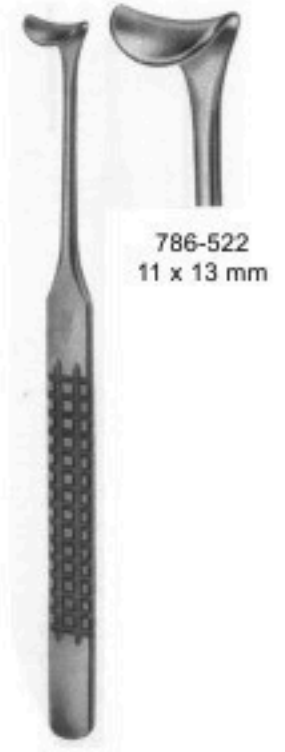

786-521
16 cm

786-522
11 x 13 mm



RETRACTORS

- Ранорасширители
- Ecarteurs
- Wundhaken

- Ранорозширювачі
- Separadores
- الكامشات

25 x 10 mm
22 x 10 mm



28 x 12 mm
32 x 12 mm
786-523
Farabeuf
12,5 cm

24 x 16 mm
28 x 16 mm



24 x 16 mm
28 x 16 mm
786-524
Farabeuf
15 cm

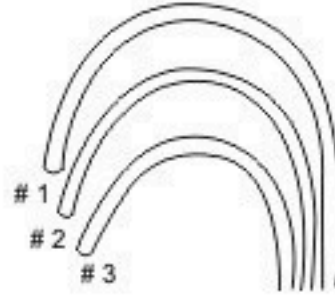

786-525
Roux - Set
16,5 cm
Consisting of:
786-526 19 x 22 mm
23 x 30 mm
786-527 25 x 26 mm
28 x 38 mm
786-528 28 x 29mm
33 x 45 mm

786-526 29 mm
786-227 26 mm
786-528 22 mm

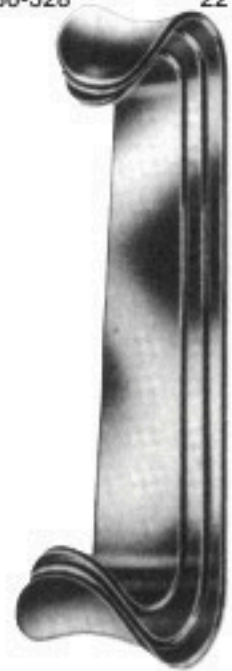

28 mm
38 mm
45 mm



786-529
30 x 10 mm



786-530
40 x 10 mm



786-531
43 x 13 mm



786-529
Langenbeck
23 cm



786-532
25 x 6 mm



786-533
35 x 8 mm



786-534
35 x 11 mm



786-535
35 x 15 mm

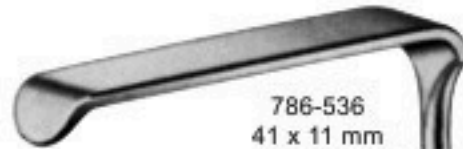

786-536
41 x 11 mm



786-537
55 x 11 mm



786-532
Kocher-Langenbeck
21,5 cm



CHEEK RETRACTORS

- Щек Ранорасширители
- rétracteurs Cheek
- Los Wundhaken Mejillas
- Щек Ранорасширители
- retrattori di guance
- الكامشات الخد



786-538
Middeldorpf



786-538
15 x 15 mm
22 cm



786-539
20 x 22 mm
21.5 cm



786-540
28 x 28 mm
23.5 cm



786-541
Greene
22,5 cm



786-542
Buchs
20,5 cm



786-543
Langenbeck
21 cm



786-543
28 x 10 mm



786-544
28 x 14 mm



786-545
33 x 14 mm



786-546
28 x 16 mm



786-547
40 x 10 mm



786-548
40 x 13 mm



786-549
Kocher
21 cm



23 x 8 mm



786-550
Alm
7 cm



Sharp
Blunt



786-551
Alm
10 cm

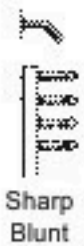

Sharp
Blunt



ELEVATORS

- Ліфти
- ascenseurs
- Elevadores

- Лифты
- Ascensori
- أسسینموري



786-552
Williger
16.5 cm



786-553
Williger
17 cm

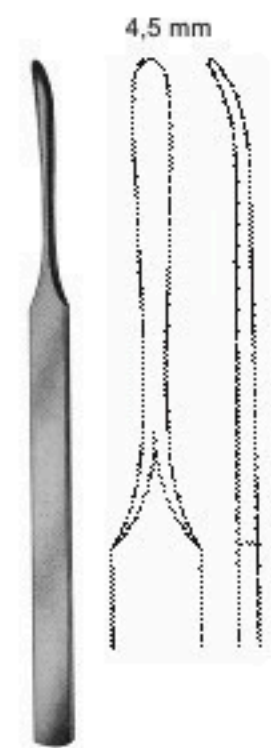

786-554
Konig
15.5 cm

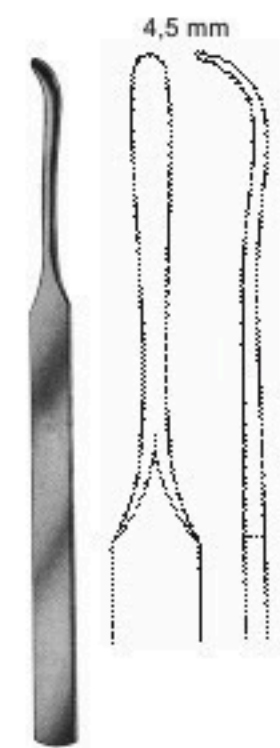

786-555
Konig
15.5 cm



786-556
Freer
19 cm



786-557
Freer
18.5 cm

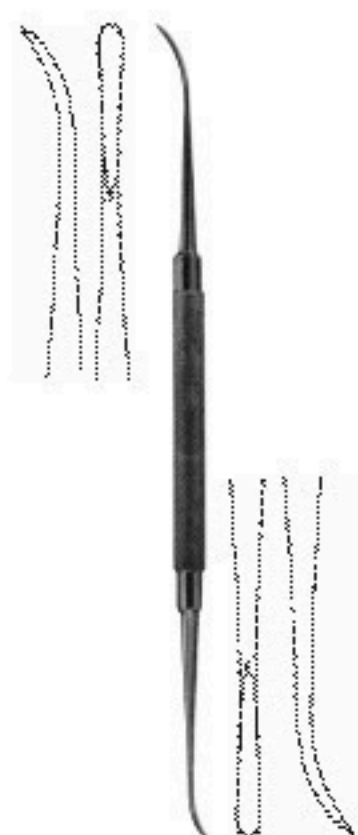

786-558
Freer-Yasargin
18.5 cm



786-559
Kendzia
17 cm



RASPATORIES

- pacnatorop
- Rugines
- Raspatories

- Pacnatorop
- Periostotomi
- الجهاز التن

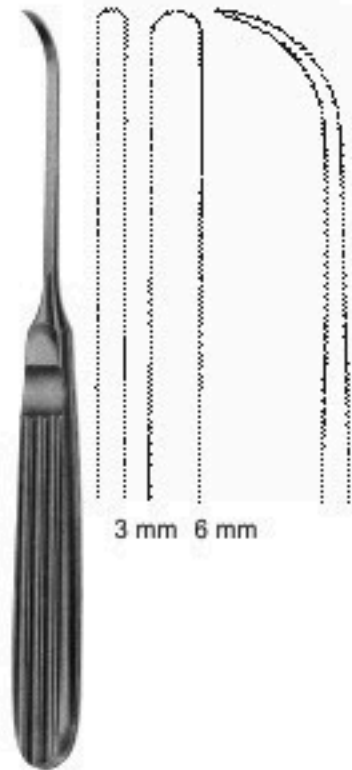

786-560 3 mm
786-561 6 mm
17 cm

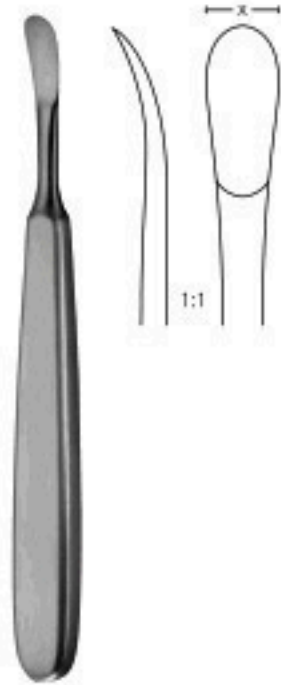

786-562 8 mm
Trelat
14 cm

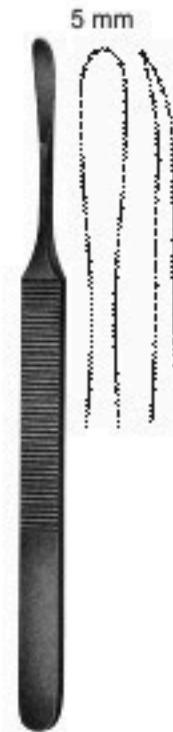

786-563
Konig
15,5 cm



786-564
Williger
14 cm



786-565
Williger
15 cm

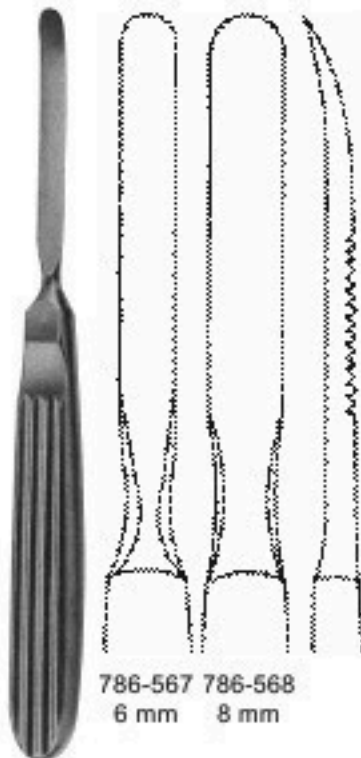

786-567 6 mm
786-568 8 mm

786-566 6 mm
16,5 cm

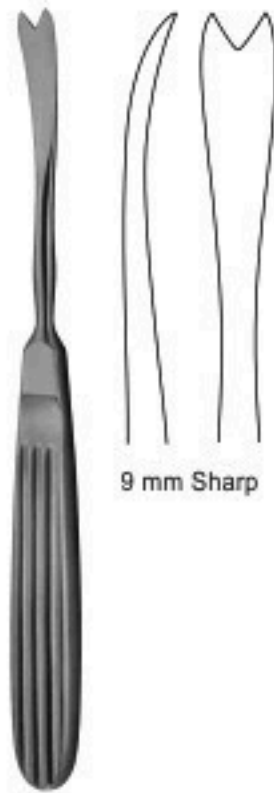

786-569
Obwegeser
17 cm

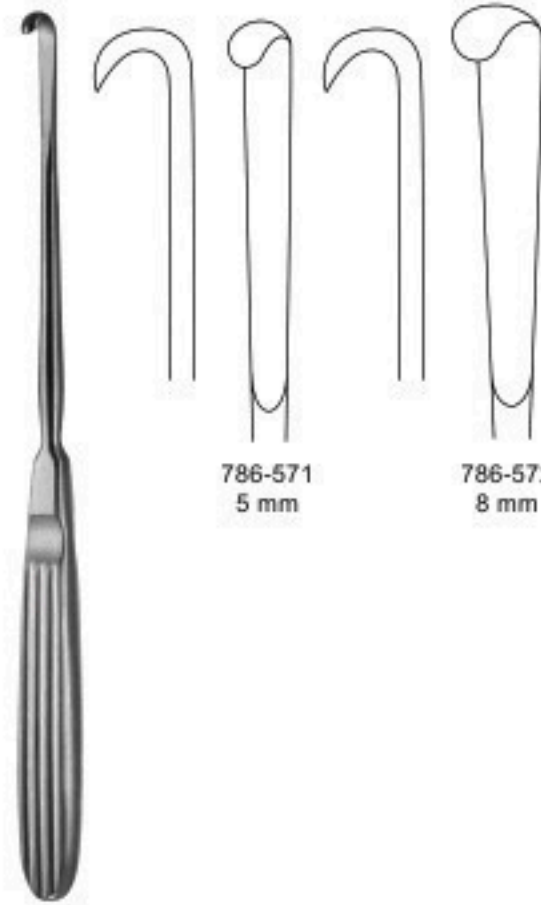

786-571
5 mm

786-572
8 mm

786-570
5 mm 1
20 cm



6 mm
Bone Curette

786-573
Tessier
22 cm



ELEVATORS

- Ліфти
- ascenseurs
- Elevadores

- Лифты
- Ascensori
- أسسینموری

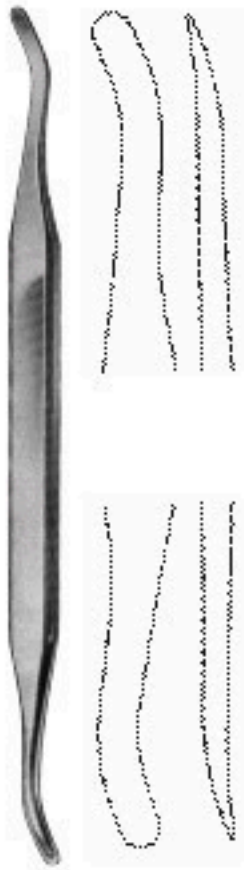

786-574
Seldin
19,5 cm

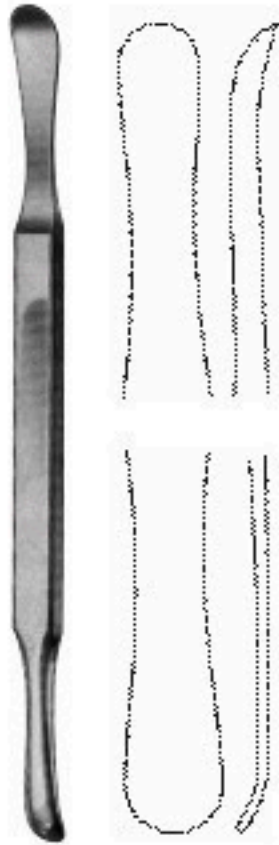

786-575
Seldin
19,5 cm



786-576
Chompret
15 cm



786-577



786-578



786-579



786-580



786-581
Freer
16 cm



786-582
Freer
16 cm



786-583
Partsch, mod
14,5 cm



786-584
Mead
16,5 cm



786-585
Mead
18 cm



CHISELS & GOUGES

- Зубила и Гуж
- Ciseaux et gouges
- Cinceles y Gouges

- Зубила і Гуж
- Scalpelli & Gouges
- الأزاميل والحفارات



786-586
Parsch
17 cm



786-587
Freer
16 cm

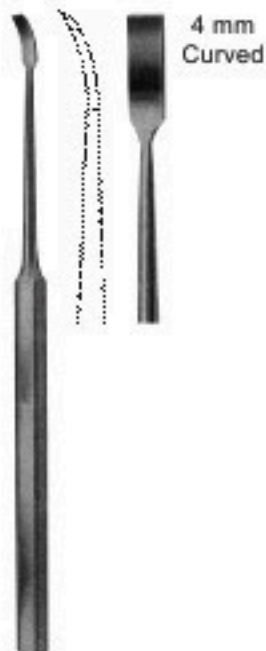

786-588
Freer
16 cm



786-589
Freer
16 cm



786-590
Lucas
16 cm



786-591
Lambotte
12,5 cm



786-592
14 cm



786-593
Partsch
14 cm



786-594
Partsch
17 cm



786-595
Partsch
14 cm



RUBBER DAM INSTRUMENTS

- Инструменти коффердама
- Instruments digue
- Instrumentos dique de goma

- Инструменты коффердама
- Gomma Instruments Dam
- المطاط آلات السد



786-596
Ivory light weight
17 cm

Clamp Forceps



786-597
Brewer
17,5 cm



786-598
Stocke
17,5 cm



786-599
Anisworth
17 cm

Punch Forceps



786-600
Ivory
17 cm

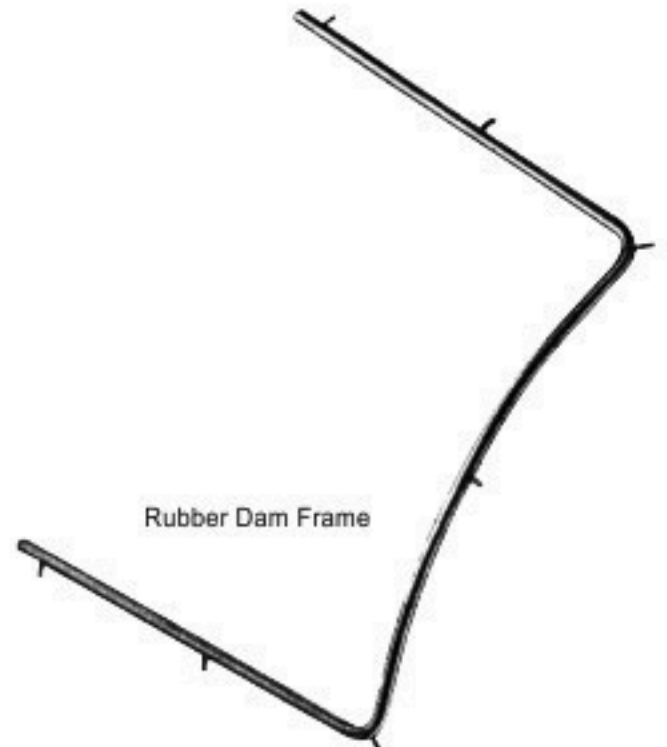

Rubber Dam Frame

786-601



TISSUE PLIERS

- тканина Кліщі
- Pince à tissus
- Pinzas de tejido

- Инструменты коффердама
- Pinze dei tessuti
- كماشة الأنسجة

786-602
Fig.1
Adson
12cm



786-603
Fig.1
Adson 1x2
12cm



786-604
Fig.1
Semken-Taylor
12.5cm



786-605
Fig.2
Semken-Taylor
12.5cm



786-606
Fig.1
Semken-Taylor 1x2
12.5cm



786-607
Fig.2
Semken-Taylor 1x2
12.5cm



786-608
12cm



786-609
11.5cm



786-610
11.5cm



786-611
11.5cm





COTTON & DRESSING PLIERS

- Бавовна і Туалетний Кліщі
- Cotton & Dressing Pincers
- Cotton & Dressing Alicates

- Хлопок и Туалетный Клещи
- Cotton & Dressing Pinze
- القطن وخلع الملابس كمامة

786-612 15 cm	Suture Plier	
786-613 Fig.1 15 cm	Goldman-Fox (Crane-Kaplane)	
786-614 Fig.2 15 cm	Goldman-Fox (Crane-Kaplane)	
786-615 Fig.1 15 cm	Self-Locking	
786-616 Fig.2 15 cm	Self-Locking	
786-617 Fig.1 15 cm	Flagg	
786-618 Fig.2 15 cm	London College	
786-619 Fig.3 16 cm	Meriam	
786-620 Fig.4 13 cm	Perry	
786-621 Fig.18L 16 cm	Self-Locking	
786-622 Fig.2 16 cm	College	
786-623 Fig.3 16 cm		



MOUTH MIRRORS

- рот дзеркал
- Miroirs De Bouche
- Espejos de la boca

- Рот зеркал
- Specchi bocca
- مرايا الفم

Handles For Mouth Mirrors



786-624
Plane 4
22 mm
Plane 5
24 mm



786-625
Magnifying 4
22 mm
Magnifying 5
24 mm



786-626
Plane 4
22 mm
Plane 5
24 mm

With cone-socket



786-627
Magnifying 4
22 mm
Magnifying 5
24 mm



786-628



786-629
Hollow



786-630



786-631
Hollow



SCALPEL HANDLES

- скальпель ручки
- Miroirs De Bouche
- bisturí mangos

- Скальпель ручки
- Scalpel Maniglie
- مشرط مقابض



786-632
Fig. 3L



786-633
Fig. 7



786-634
Fig. 5



786-635
Fig. 5A



786-636
Fig. 3



786-637
Fig. 3G



786-638
Fig. 4



HANDLES REFERENCE GUIDE

- скальпель ручки
- Poignées Guide de référence
- Maneja Guía de referencia
- Ручки Довідкове керівництво
- Maniglie Guida di riferimento
- يعالج الدليل المرجعي



A
Single Ended
Knurling round



B
Double Ended
Knurling round



C
Single Ended
Octangle serrated



D
Double Ended
Octangle round



E
Single Ended
Hollow round



F
Double Ended
Hollow round



G
Double Ended
Hollow round
grooved



H
Double Ended
Swiss pattern
octangle

Note:
If you have preference different from the standard handle shown, specify the optional handle number when ordering. If the tip/handle combination you desire is not shown, we will be glade to provide you with a quote for its preparation



EXPLORERS

- исследователей
- explorateurs
- Exploradores

- Ручки Довідкове керівництво
- esploratore
- المستكشفين

Endodontic Instruments



786-639
Fig. 23



786-640
Fig. 2



786-641
Fig. 16



786-642
Fig. 9



786-643
Fig. 10



786-644
Fig. 12



786-645
Fig. 11



786-646
Fig. 6



786-647
Fig. 8



786-648
Fig. 5



786-649
Fig. 17



786-650
Fig. 17A



786-651
Fig. 3



786-652
Fig. 3A



786-653
Fig. 1
S[reader



786-654
Fig. 2
S[reader

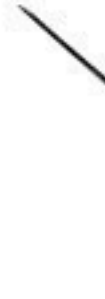

786-655
Fig. 3
S[reader



786-656
Fig. 4
S[reader



786-657
Fig. 5
S[reader



786-658
Fig. 6
S[reader



786-659
Fig. 7
S[reader



PERIODONTAL POCKET PROBES

- Зонди пародонту Кишенькова
- Sondes poche parodontale
- Sondas bolsa periodontal
- Зонды пародонта Карманная
- Sonde tasca parodontale
- المسابر جيب اللثة

Endodontic Instruments



786-660
Williams

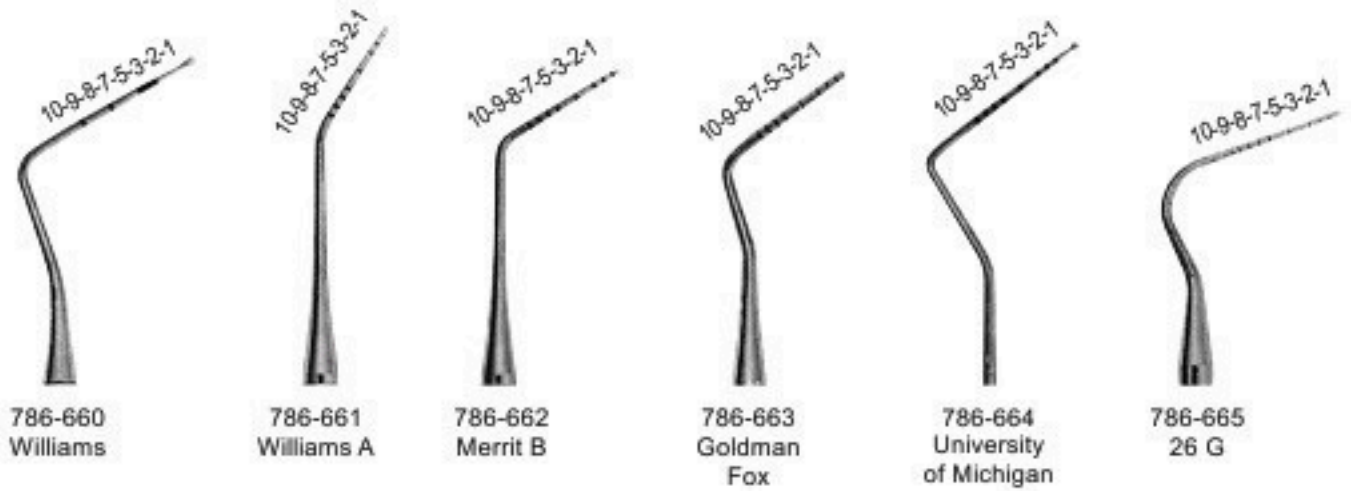

786-660 Williams

786-661 Williams A

786-662 Merrit B

786-663 Goldman Fox

786-664 University of Michigan

786-665 26 G

Color - Coded

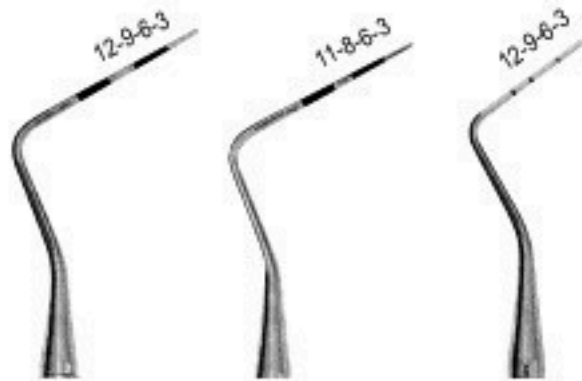

786-666 CP-12S O.M.S

786-667 CP-11

786-668 CP-12

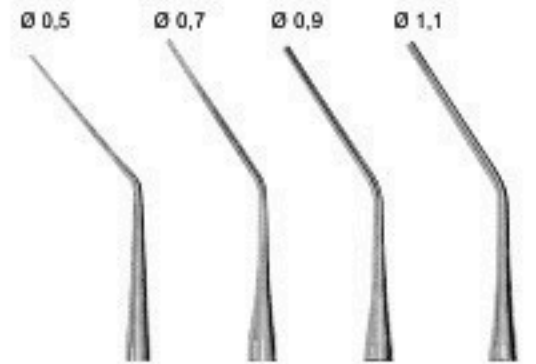

786-669 Fig. 1 Luks

786-670 Fig. 2 Luks

786-671 Fig. 3 Luks

786-672 Fig. 4 Luks

Root-Canal pluggers

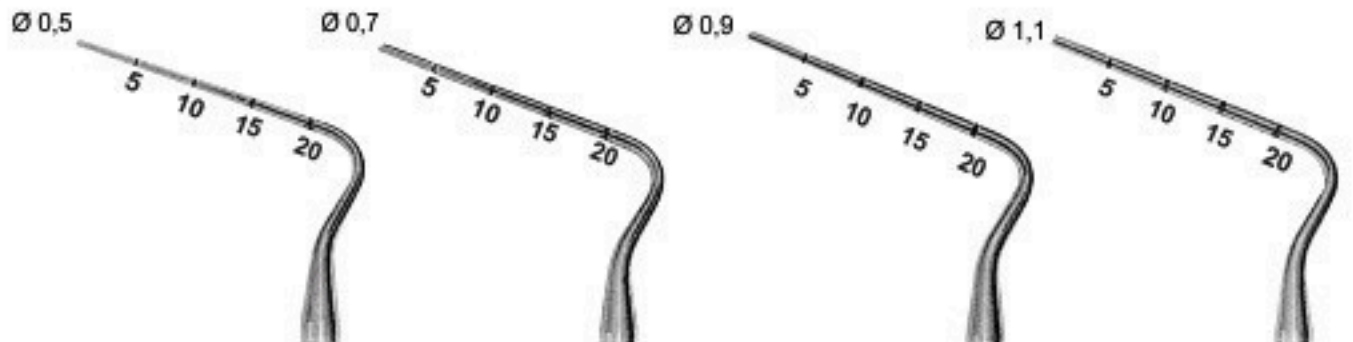

786-673 Fig. 1 Vertical Condenser

786-674 Fig. 2 Vertical Condenser

786-675 Fig. 3 Vertical Condenser

786-676 Fig. 4 Vertical Condenser



EXPLORERS

- исследователей
- explorateurs
- Exploradores

- Ручки Довідкове керівництво
- esploratore
- المستكشفين

Probes



786-678
Fig. 23/17

786-679
Fig. 23/17A

786-680
Fig. 2

786-681
Fig. 2A

786-682
Fig. 3

786-683
Fig. 16/23

786-684
Fig. 16/3

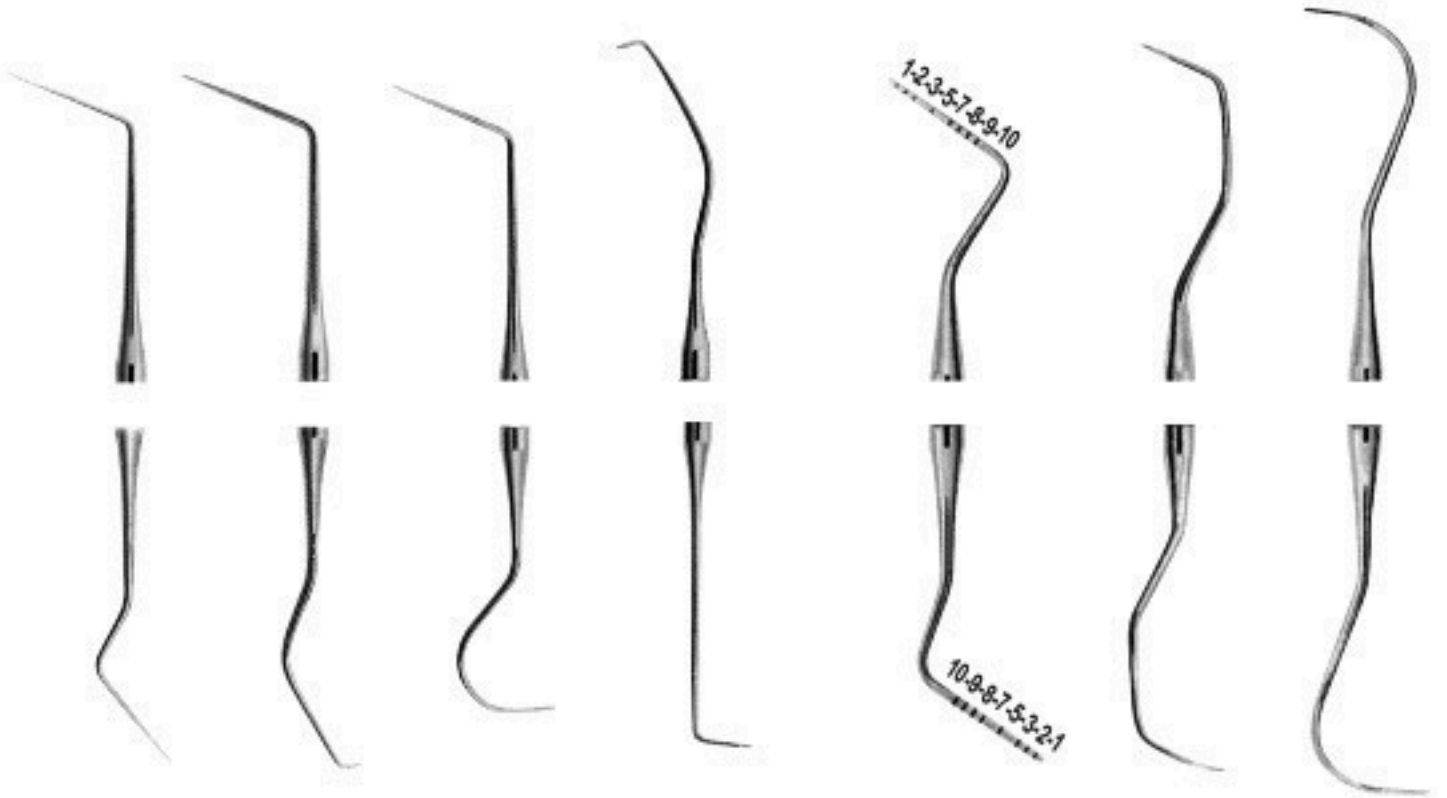

786-677
Fig. UT 1/2
Cattoni

786-685
Fig. 6/1

786-686
Fig. 6/17

786-687
Fig. 6/23

786-688
Fig. UT 1/2
Cattoni

786-689
Goldman-Fox
Williams

786-690
Fig. 1 N

786-691
Fig. 2N
Nabers



EXPLORERS

- исследователей
- explorateurs
- Exploradores

- Ручки Довідкове керівництво
- esploratore
- المستكشفين

Endodontic Instruments



786-693 UM
Fig. 23
University of Michigan

786-694 W
Fig. 23
Williams

786-695 GF
Fig. 17
Goldman-Fox

786-696 UM
Fig. 17
University of Michigan

786-697 W
Fig. 17
Williams

786-698
Fig. 23/CP11

786-699
Fig. 23/CP12



786-692 GF
Fig. 23
Goldman-Fox

786-700 GF
Fig. 3
Goldman-Fox

786-701 UM
Fig. 3
University of Michigan

786-702 W
Fig. 3
Williams

786-703 GF
Fig. 16
Goldman-Fox

786-704 UM
Fig. 16
University of Michigan

786-705 W
Fig. 16
Williams



FILLING INSTRUMENTS

- Инструменты для реставрации
- Instruments pour plombage
- Füllungsinstrumente (mit Kontrawinkel)

- Інструменти для реставрації
- Instrumentos para obturaciones
- ملء الصكوك

Amalgam Instruments



786-706
Fig. 1

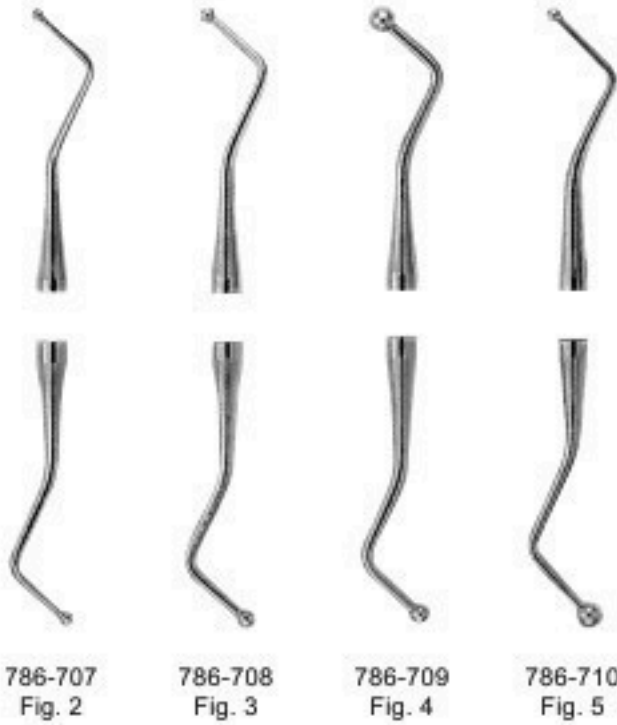

786-707
Fig. 2

786-708
Fig. 3

786-709
Fig. 4

786-710
Fig. 5



786-711
Fig. 1

786-712
Fig. 2

786-713
Fig. 3

Smooth

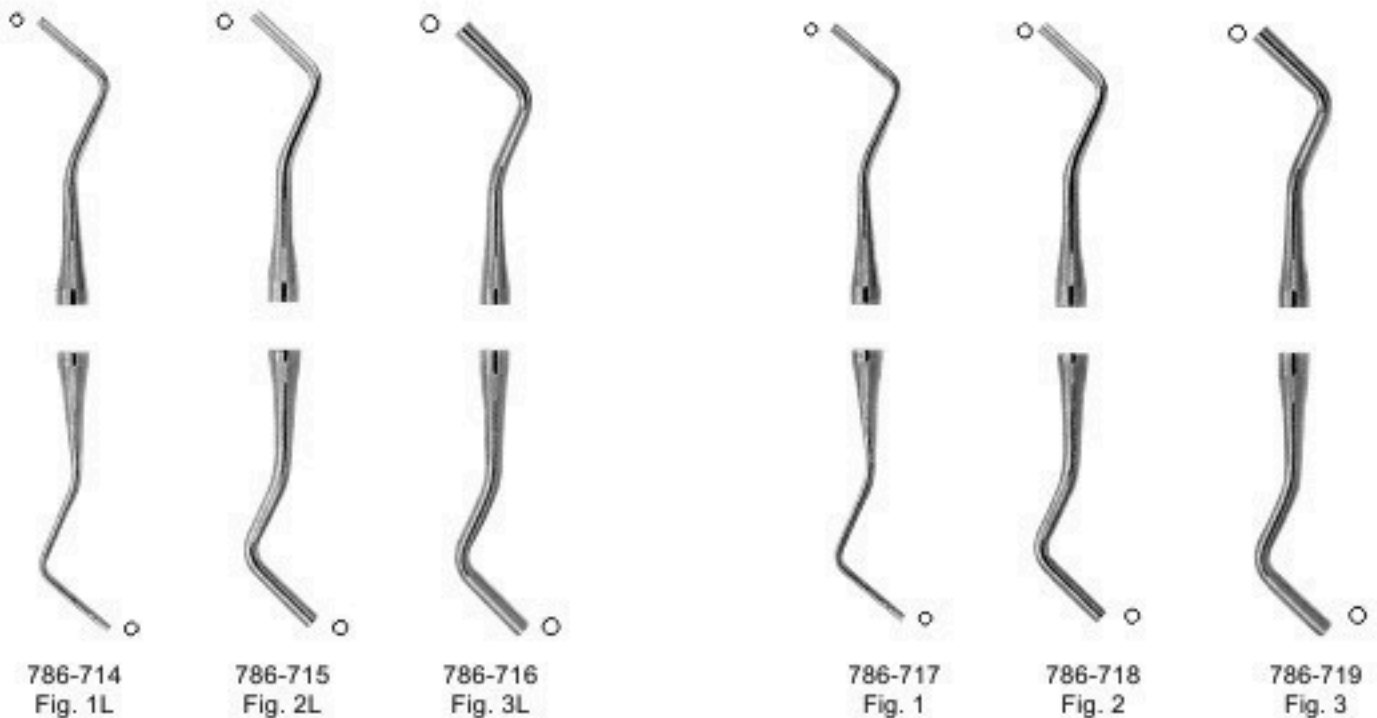

786-714
Fig. 1L

786-715
Fig. 2L

786-716
Fig. 3L

786-717
Fig. 1

786-718
Fig. 2

786-719
Fig. 3



FILLING INSTRUMENTS

- Инструменты для реставрации
- Instruments pour plombage
- Füllungsinstrumente (mit Kontrawinkel)

- Інструменти для реставрації
- Instrumentos para obturaciones
- ملء الصكوك

Amalgam Instruments



786-720
Fig. 1

Serrated



786-720
Fig. 1



786-721
Fig. 2



786-722
Fig. 3



786-723
Fig. 4



786-724
Fig. 1L

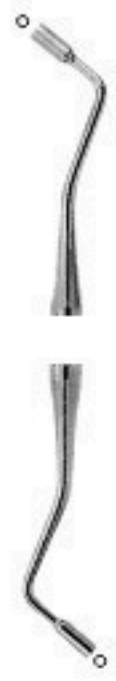

786-725
Fig. 2L



786-726
Fig. 3L



786-727
Fig. 4L

Smooth



786-728
Fig. 1
Ward



786-729
Fig. 2
Ward



786-730
Fig. 0T
Tanner



786-731
Fig. 1T
Tanner



786-732
Fig. 2T
Tanner



786-733
Fig. 3T
Tanner



786-734
Fig. 01
Marquette
Serrated



FILLING INSTRUMENTS

- Инструменты для реставрации
- Instruments pour plombage
- Füllungsinstrumente (mit Kontrawinkel)

- Інструменти для реставрації
- Instrumentos para obturaciones
- ملء الصكوك

Amalgam Instruments



786-735
Fig. 1

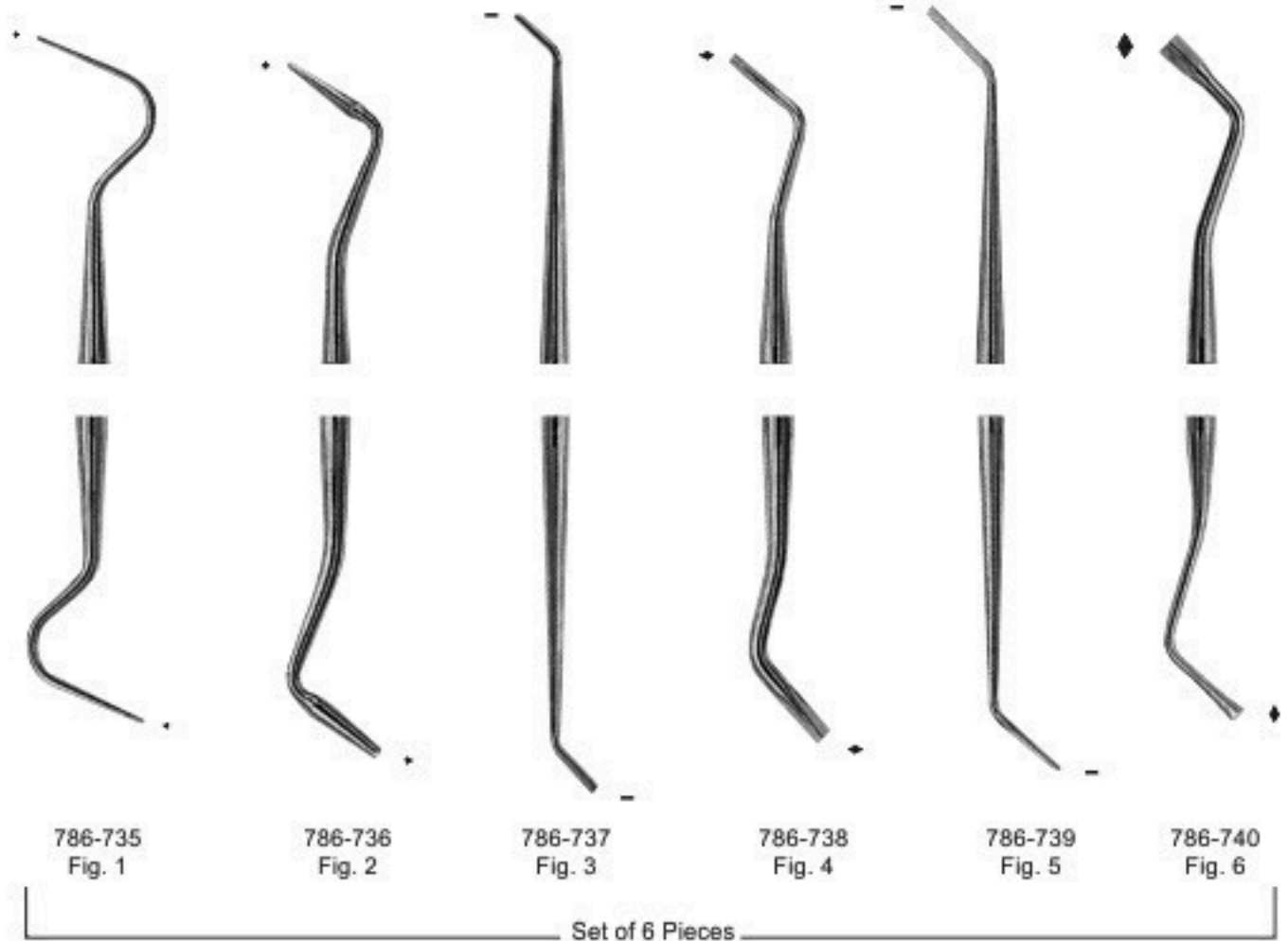

786-735
Fig. 1

786-736
Fig. 2

786-737
Fig. 3

786-738
Fig. 4

786-739
Fig. 5

786-740
Fig. 6

Set of 6 Pieces

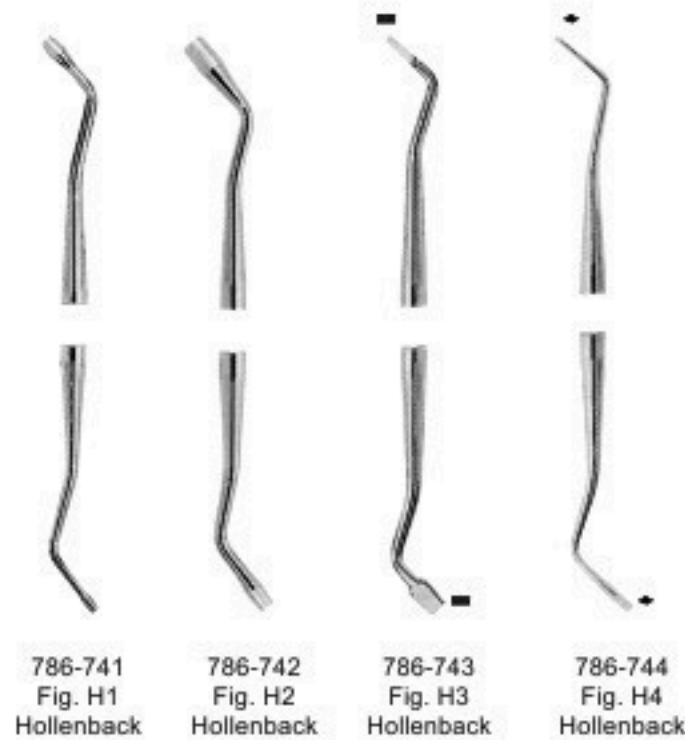

786-741
Fig. H1
Hollenback

786-742
Fig. H2
Hollenback

786-743
Fig. H3
Hollenback

786-744
Fig. H4
Hollenback



FILLING INSTRUMENTS

- Инструменты для реставрации
- Instruments pour plombage
- Füllungsinstrumente (mit Kontrawinkel)

- Інструменти для реставрації
- Instrumentos para obturaciones
- ملء الصكوك

Plastic Filling Instruments

Burnishers

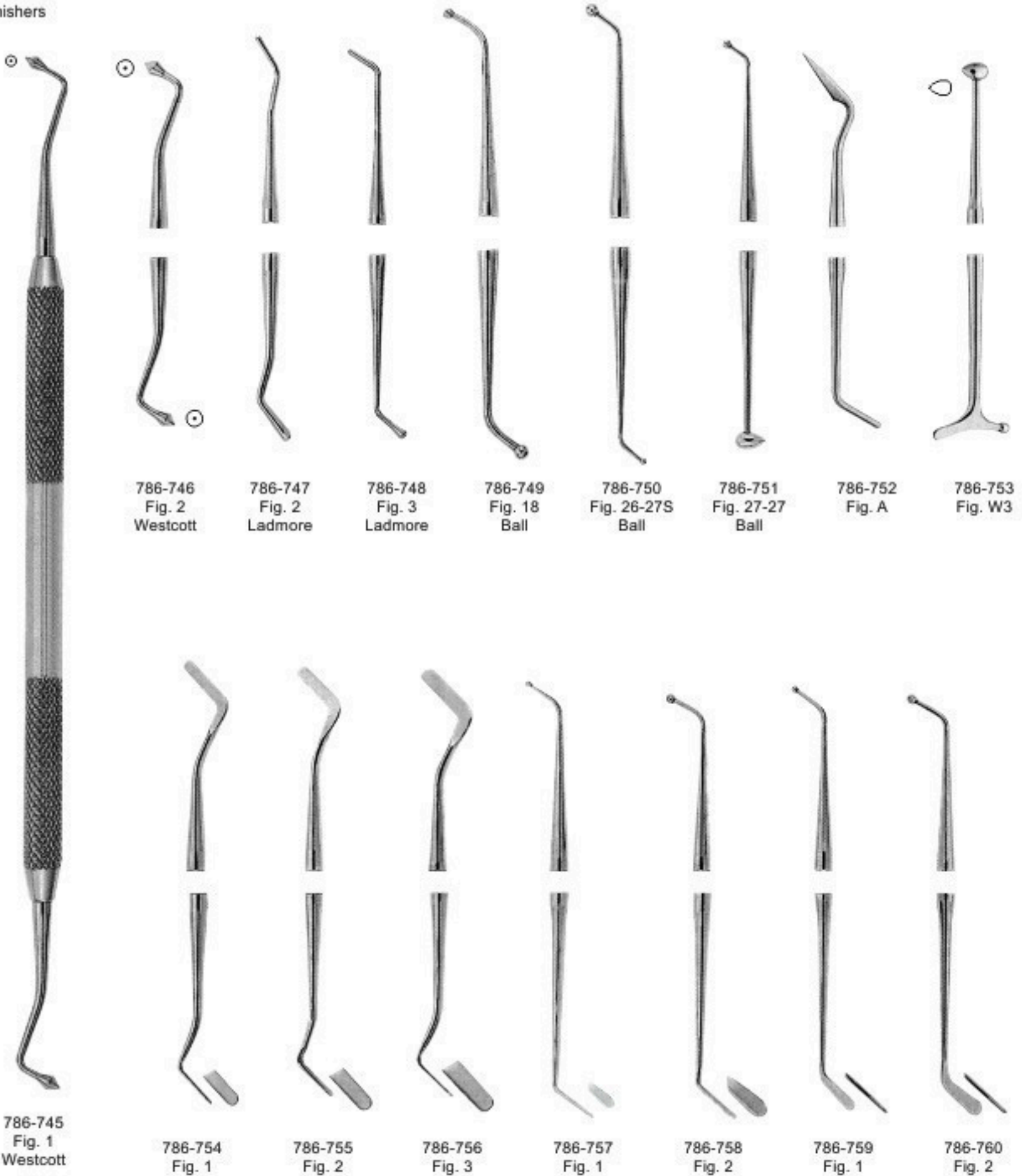



PLASTIC FILLING INSTRUMENTS

- Инструменты для реставрации
- Instruments pour plombage
- Füllungsinstrumente (mit Kontrawinkel)

- Инструменти для реставрації
- Instrumentos para obturaciones
- ملء الصكوك

Amalgam Carvers

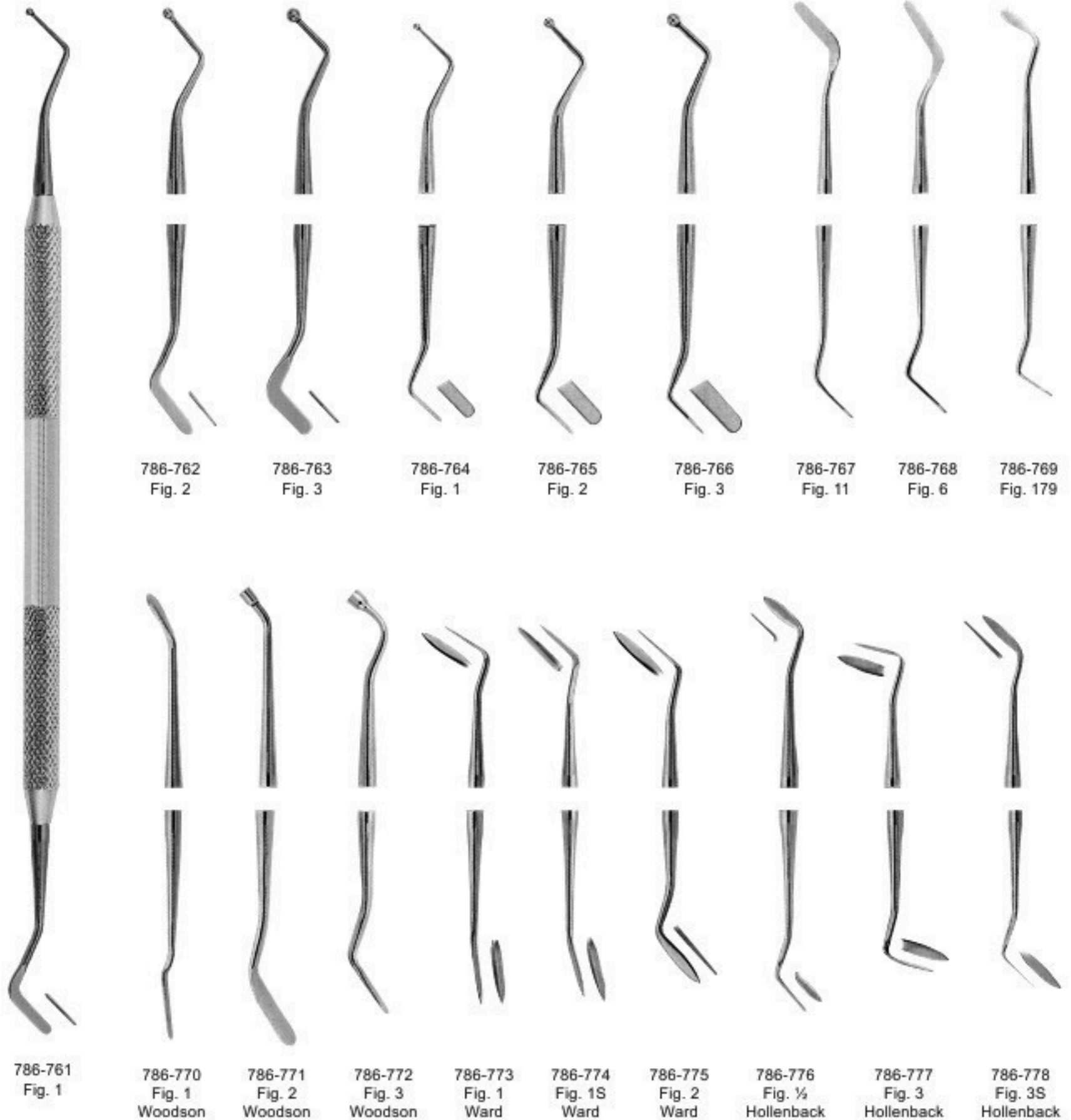



AMALGAM CARVERS

- Инструменты для реставрации
- Instruments pour amalgame
- Amalgampistolen

- Інструменти для реставрації
- instrumentos para amalgama
- تقطيع الملغم

Operative Instruments



786-779
Fig. 1
Frahm

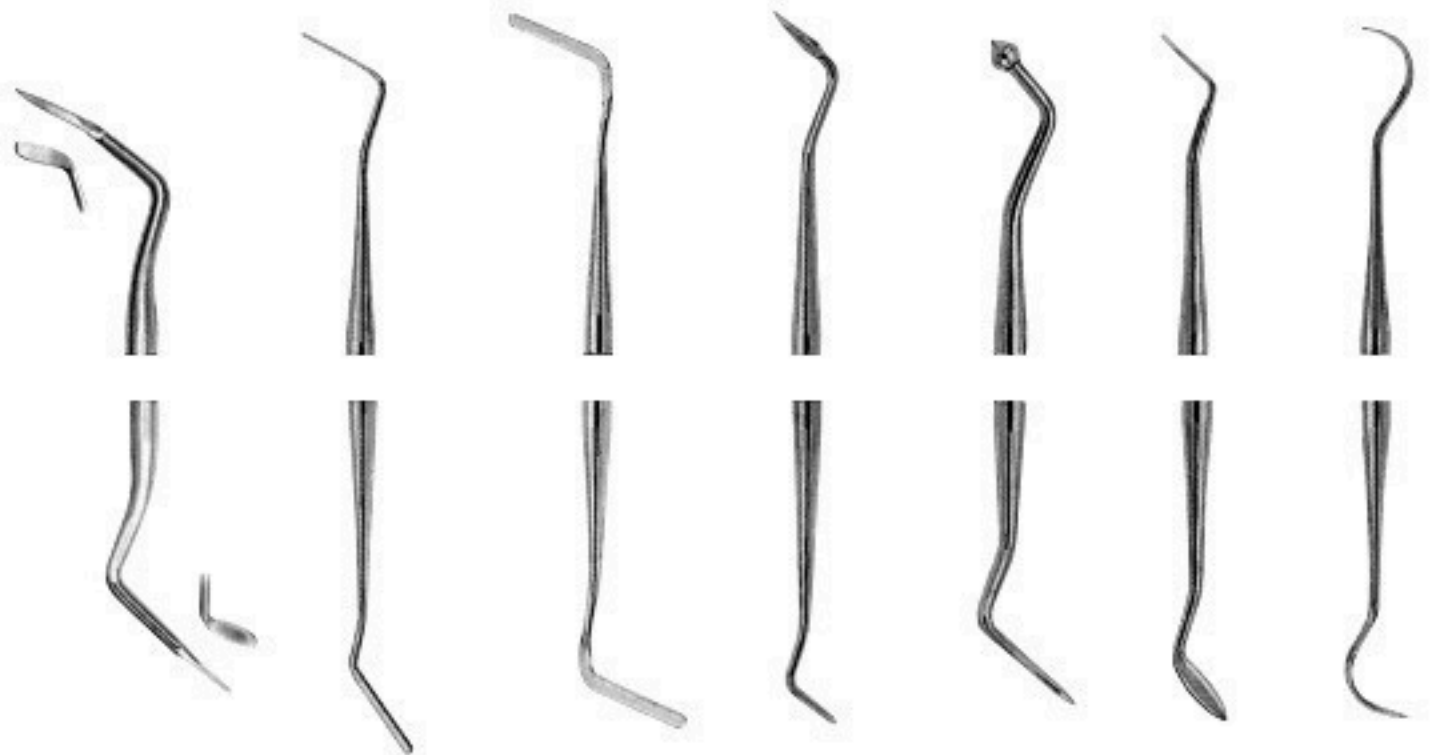

786-780
Fig. 2
USC

786-781
Fig. 1
Interproximal

786-782
Fig. 2
Interproximal
Off-Angle

786-783
Fig. SHO-A

786-784
Fig. 3-SHO

786-785
Fig. 104

786-786
Fig. 8
Willand

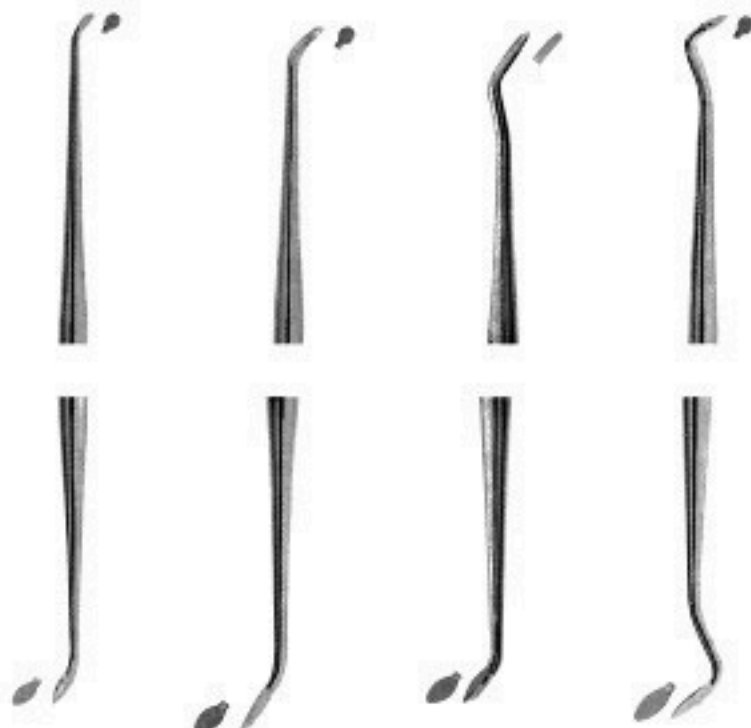

786-787
Fig. 1

786-788
Fig. 2

786-789
Fig. 3

786-790
Fig. 4

Cleoids-Discoids



786-791



786-792

786-793

instruments for subgingival application
of tinctures and medicaments



CAVITY PREPARATION INSTRUMENTS

- Препарування порожнини інструменти Хірургічні ножиці
- Préparation de la cavité Instruments Ciseaux chirurgicaux
- Cavità strumenti di preparazione Forbici chirurgiche
- أدوات إعداد تجويف مقص جراحي
- Препарирование полости инструменты Хирургические ножницы

Gingival Margin Trimmers



786-795
Fig. 2
Black/27



786-796
Fig. 3
Black/28



786-797
Fig. 4
Black/29



786-798
Fig. 1
Black/77-78



786-799
Fig. 2
Black/79-80



786-800
Fig. 1
Black/53-54



786-801
Fig. 2
Black/51-52



786-794
Fig. 1
Black/26



786-802
Fig. 1/2
Wedelstaet



786-803
Fig. 3/4
Wedelstaet

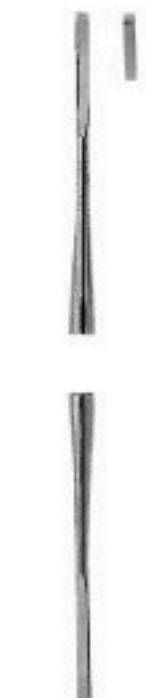

786-804
Fig. 5/6
Wedelstaet

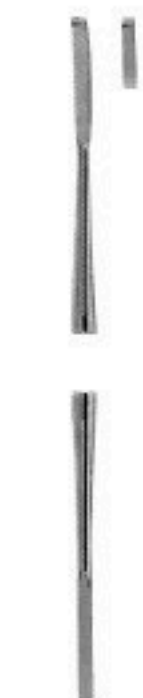

786-805
Fig. 1/2
TG Chisel





EXCAVATORS

- Экскаваторы
- Excavateurs
- Excavatoren

- Екскаватори
- Excavadores
- حفارات



786-806
Fig. 6



786-807
Fig. 14

786-808
Fig. 17

786-809
Fig. 17W
Oval spoon

786-810
Fig. 18

786-811
Fig. 18W
Oval spoon

786-812
Fig. 19

786-813
Fig. 19W
Oval spoon

025-175S Set of 5

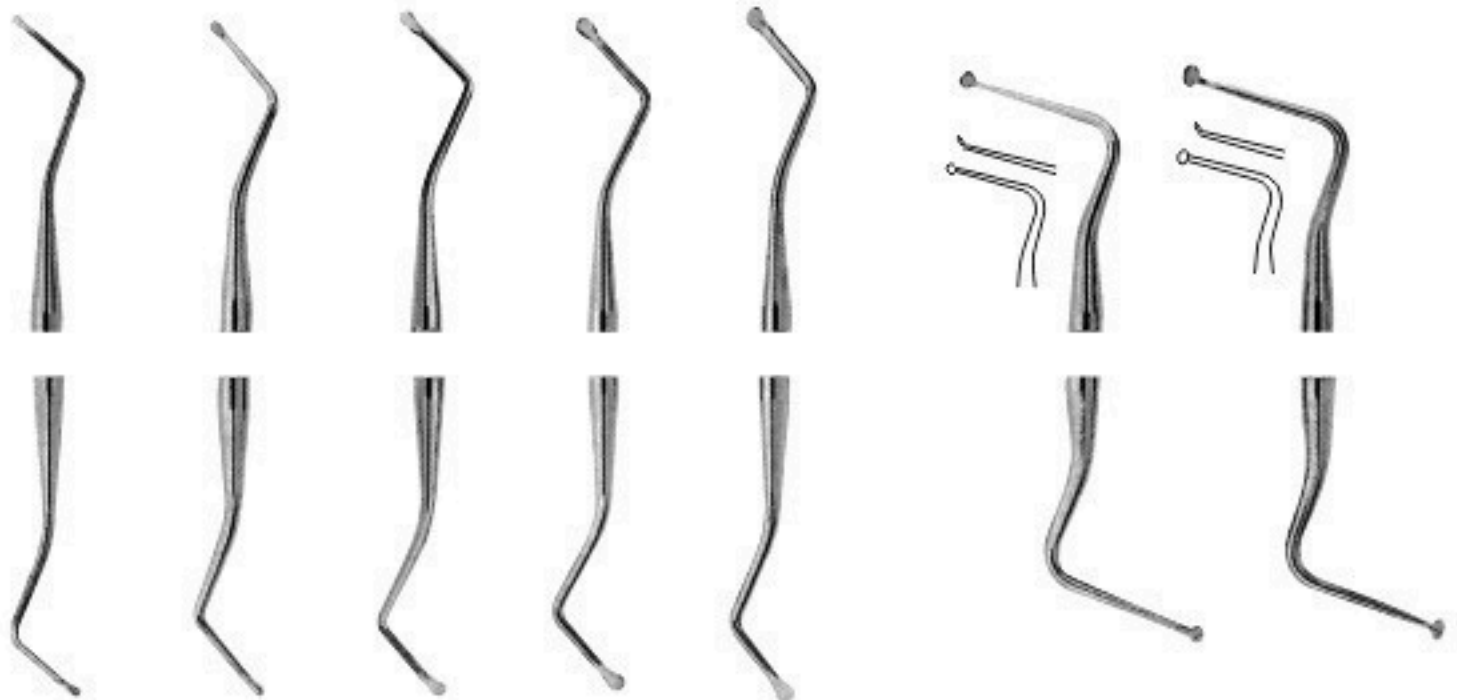

786-814
Fig. 0

786-815
Fig. 1

786-816
Fig. 2

786-817
Fig. 3

786-818
Fig. 4

786-819
Fig. 1

786-820
Fig. 2



EXCAVATORS

- Экскаваторы
- Excavateurs
- Excavatoren

- Екскаватори
- Excavadores
- حفارات



786-821
Fig. 38/39



786-822
Fig. 63/64



786-823
Fig. 65/66



786-824
Fig. 31L



786-825
Fig. 32L



786-826
Fig. 33L



786-827
Fig. 135/136



786-828
Fig. 139/140



786-829
Fig. 141/142



786-830
Fig. 113/114



786-831
Fig. 115/116



786-832
Fig. 117/118



786-833
Fig. 119/120



786-834
Fig. 121/122



786-835
Fig. 123/124



786-836
Fig. 153/154



786-837
Fig. 155/156



786-838
Fig. 158/159



786-839
Fig. 159/160



EXCAVATORS

- Экскаваторы
- Excavateurs
- Excavatoren

- Екскаватори
- Excavadores
- حفارات

English Pattern

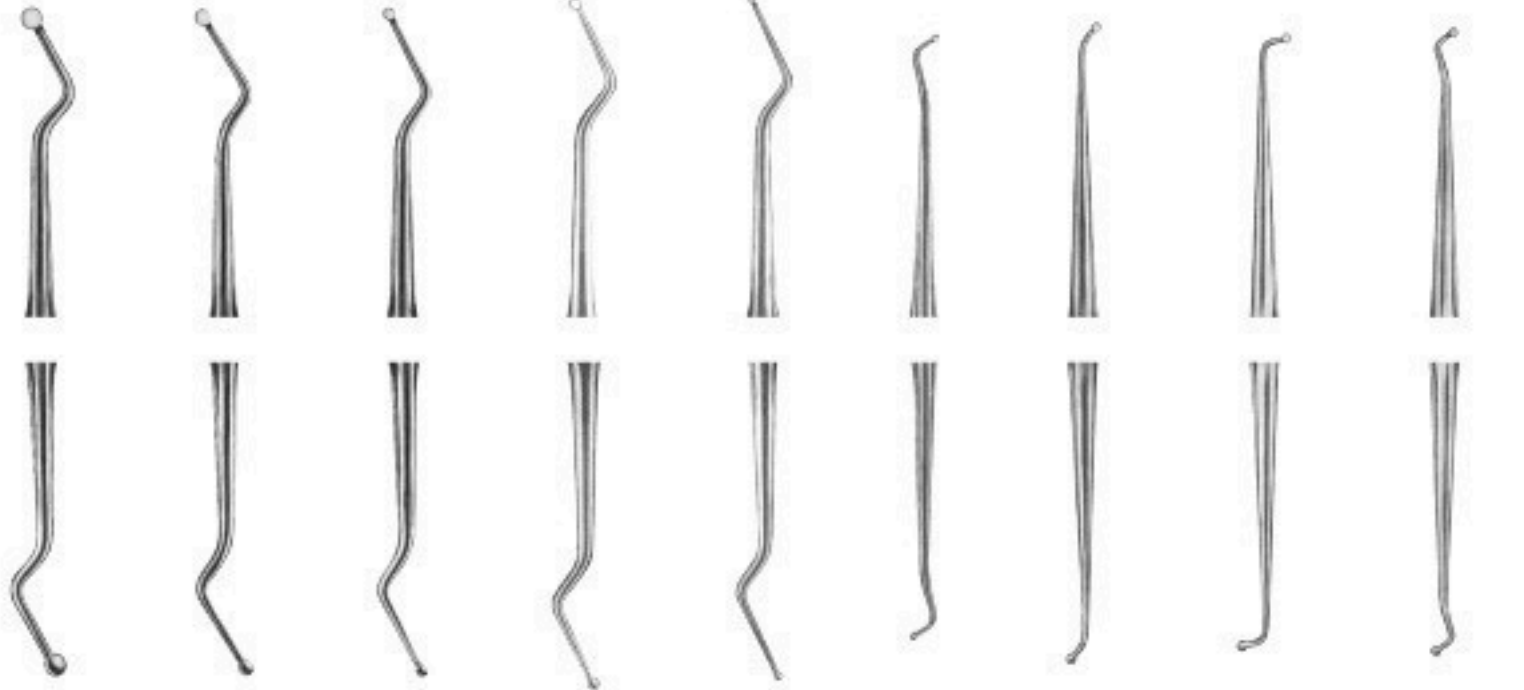

786-840 Fig. 125/126 786-841 Fig. 127/128 786-842 Fig. 129/130 786-843 Fig. 131/132 786-844 Fig. 133/134 786-845 Fig. 9/10 786-846 Fig. 204/205 786-847 Fig. 206/207 786-848 Fig. 208/209

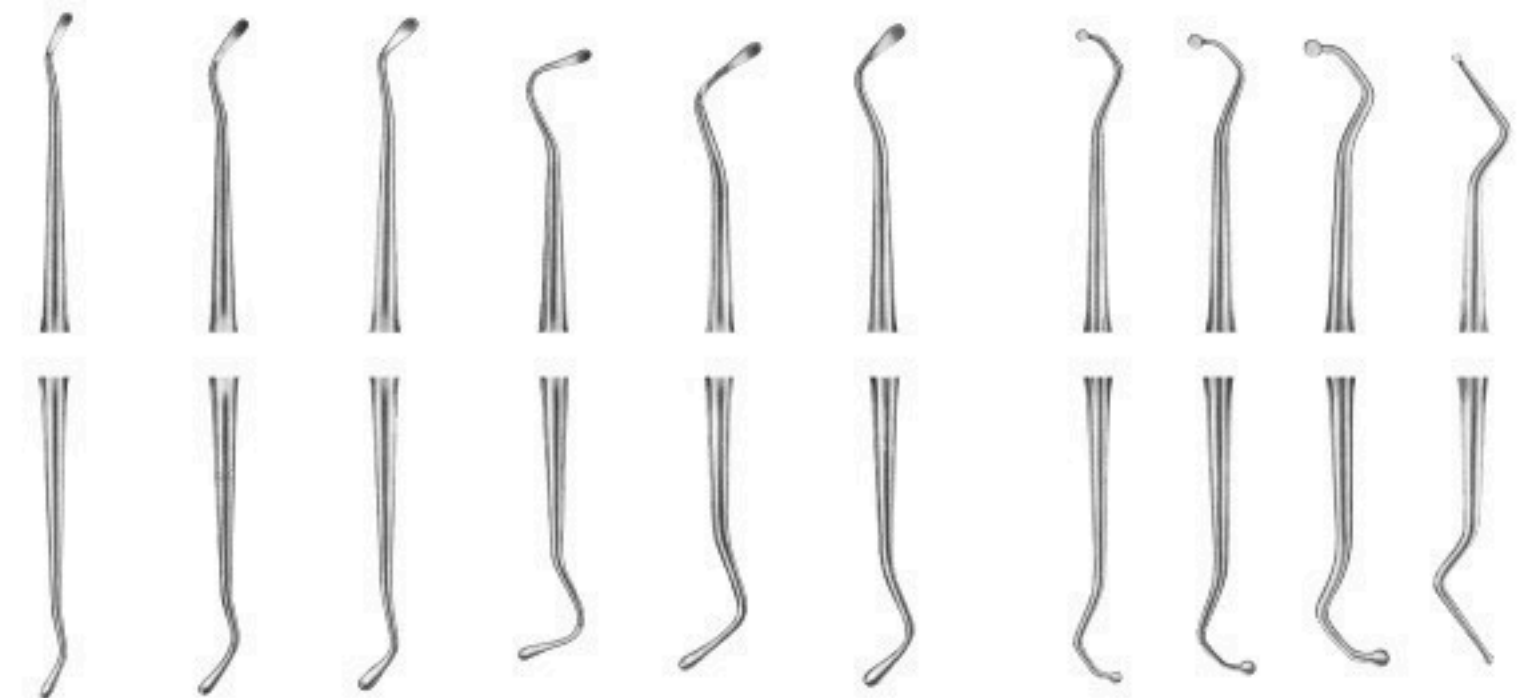

786-840
Fig. 125/126

786-849 Fig. 210/211 786-850 Fig. 212/213 786-851 Fig. 214/215 786-852 Fig. 216/217 786-853 Fig. 218/219 786-854 Fig. 220/221 786-855 Fig. 243 786-856 Fig. 244 786-857 Fig. 245 786-858 Fig. 246



PERIODONTIA INSTRUMENTS

- Инструменты пародонтологические
- Instruments pour la parodontologie
- Instrumente für die Parodontologie

- Інструменти пародонтологічні
- instrumentos para periodoncia
- الصكوك اللثة



786-859
fig. M9
Molt



786-860
fig. 1
Hopkins



786-861
fig. 2
Hopkins



786-862
fig. 3
Mead



786-863
fig. PR3
Prichard



786-864
fig. 15
Freer



786-865
fig. 16
Freer



BONE FILES

- Инструменты для костной ткани
- Limes a os
- Knochenfeilen

- Инструменти для кісткової тканини
- Limas para huesos
- ملفات العظام



786-866
fig. 12CA

786-867
fig. 12A

786-868
fig. 12
Howard

786-869
fig. 33

786-870
fig. 45
Miller



BONE FILES

- Инструменты для костной ткани
- Limes a os
- Knochenfeilen

- Інструменти для кісткової тканини
- Limas para huesos
- ملفات العظام

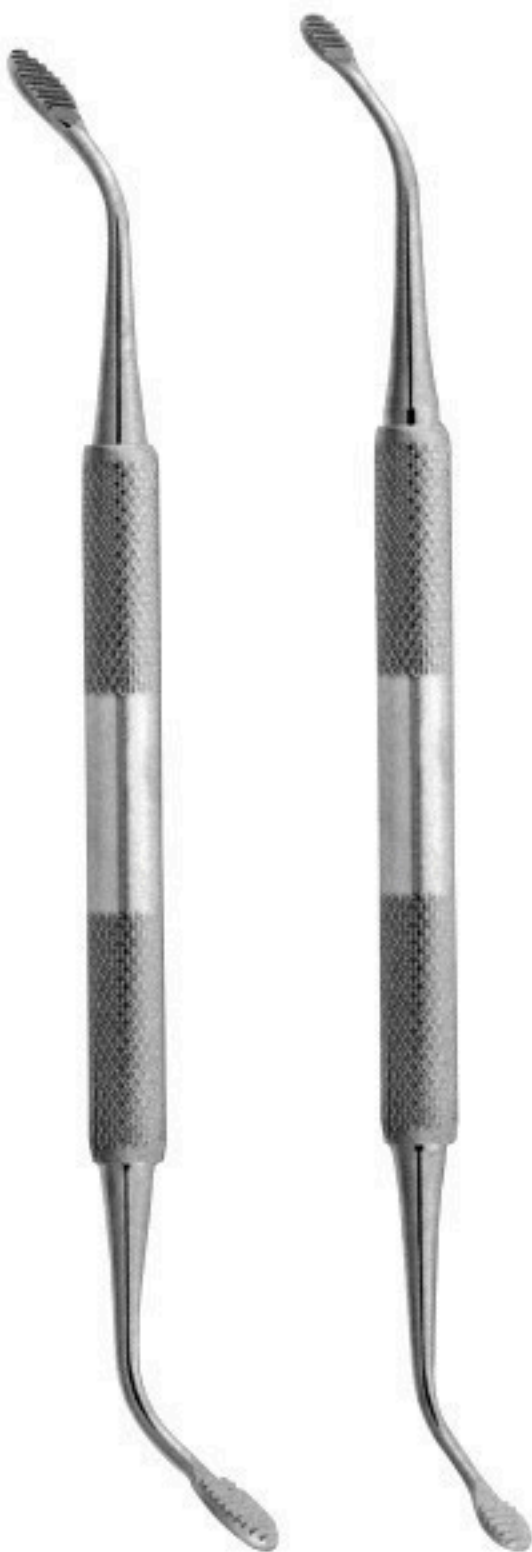

786-871
fig. 1
Wahl

786-872
fig. 2
Wahl



786-873
fig. 1
PoloKoff



786-874
fig. 64
Miller



786-875
fig. 10



BONE CURETTES

- Кость Curettes
- Curettes osseuses
- Curetas óseas

- كرتس العظام

Periodontia Instruments



786-876
Fig. 1
Hemingway



786-877
Fig. 2
Hemingway



786-878
Fig. 3
Hemingway



786-879
Fig. 4
Hemingway



786-880
Fig. 85
Lucas



786-881
Fig. 86
Lucas



786-882
Fig. 87
Lucas



786-883
Fig. 88
Lucas



786-884
Fig. 1S/2S
Sugarman



786-885
Fig. 3S/4S
Sugarman



786-886
Fig. 9/10
Schluger



786-887
Fig. 11/12
Back

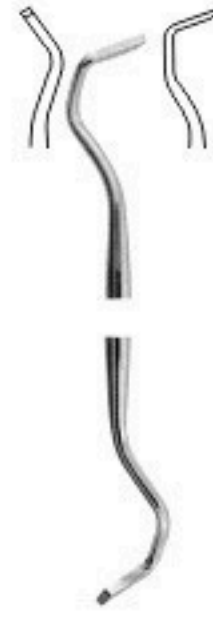

786-888
Fig. 3
Ochsenbein



786-889
Fig. 4
Ochsenbein



786-890
Fig. 36/37
Rhodes back-Action



PERIODONTIA INSTRUMENTS

- Инструменты пародонтологические
- Instruments pour la parodontologie
- Instrumente für die Parodontologie

- Інструменти пародонтологічні
- Instrumentos para periodoncia
- الصكوك اللثة



786-891
Fig. 7
Goldman-Fox



786-892
Fig. 8
Goldman-Fox



786-893
Fig. 9
Goldman-Fox



786-894
Fig. 11
Goldman-Fox

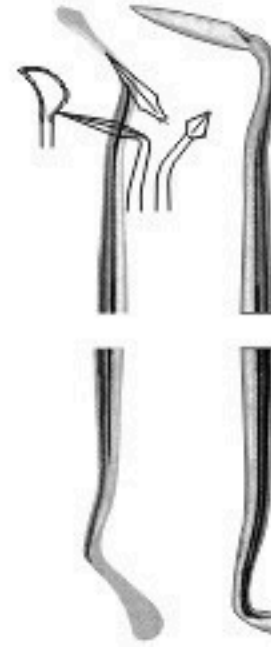

786-895
Fig. 3/4
Buck



786-896
Fig. 5/6
Buck



786-897
Fig. 1/2
(15k/16k)
Kirkland



786-898
Fig. 1/2
Orban



786-899
Fig. 1/2
Sanders



786-900
Fig. 4/5
Sanders



786-901
Fig. 19/20
(University of
South California)
USC Towner

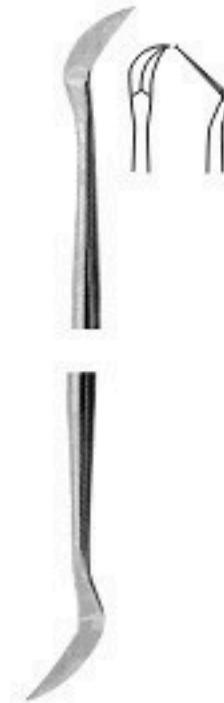

786-902
Fig. CK3
Crane-Kaplan



PERIODONTIA INSTRUMENTS

- Инструменты пародонтологические
- Instruments pour la parodontologie
- Instrumente für die Parodontologie

- Інструменти пародонтологічні
- Instrumentos para periodoncia
- الصكوك اللثة

Currettes & Scalers

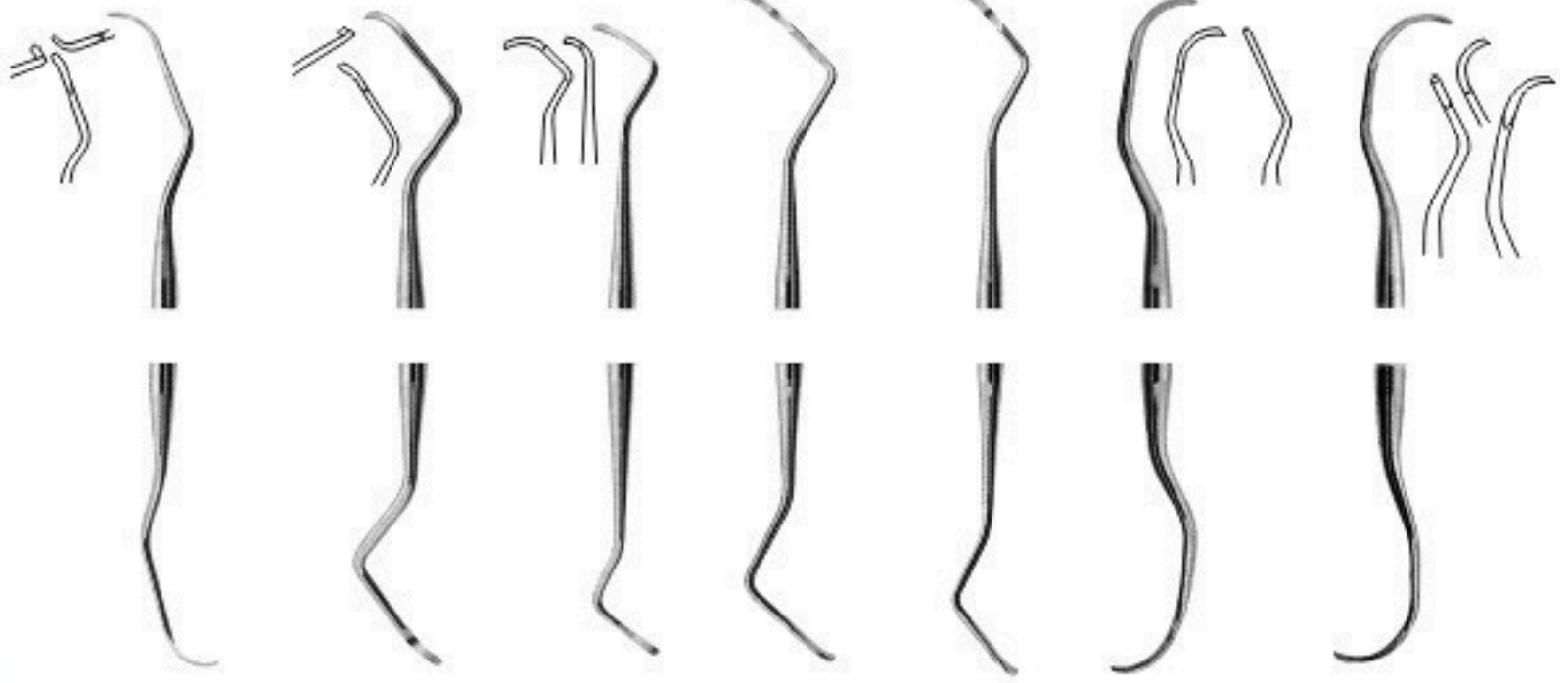

786-904
Fig. 2R/2L
Columbia

786-905
Fig. 4R/4L
Columbia

786-906
Fig. 13/14
Columbia

786-907
Fig. 411/412

786-908
Fig. 413/414

786-909
Fig. HU 1/2
Langer

786-910
Fig. 3/4
Langer



786-903
Fig. HU 1/2
Curette

786-911
Fig. 1/2
Barnhart

786-912
Fig. 5/6
Barnhart

786-913
Fig. ME-1
(10/11)

786-914
Fig. 3/4
(23/24)

786-915
Fig. 11/14
Gracey
Mesial-Distal

786-916
Fig. 12/13
Gracey
Mesial-Distal

786-917
Fig. 13/14
Indiana University
Anterior

786-918
Fig. 17/18
Indiana University
Posterior



PERIODONTIA INSTRUMENTS

- Инструменты пародонтологические
- Instruments pour la parodontologie
- Instrumente für die Parodontologie
- Инструменти пародонтологічні
- Instrumentos para periodoncia
- الصكوك اللثة

Gracey Curettes

Set of 9 025-286AS

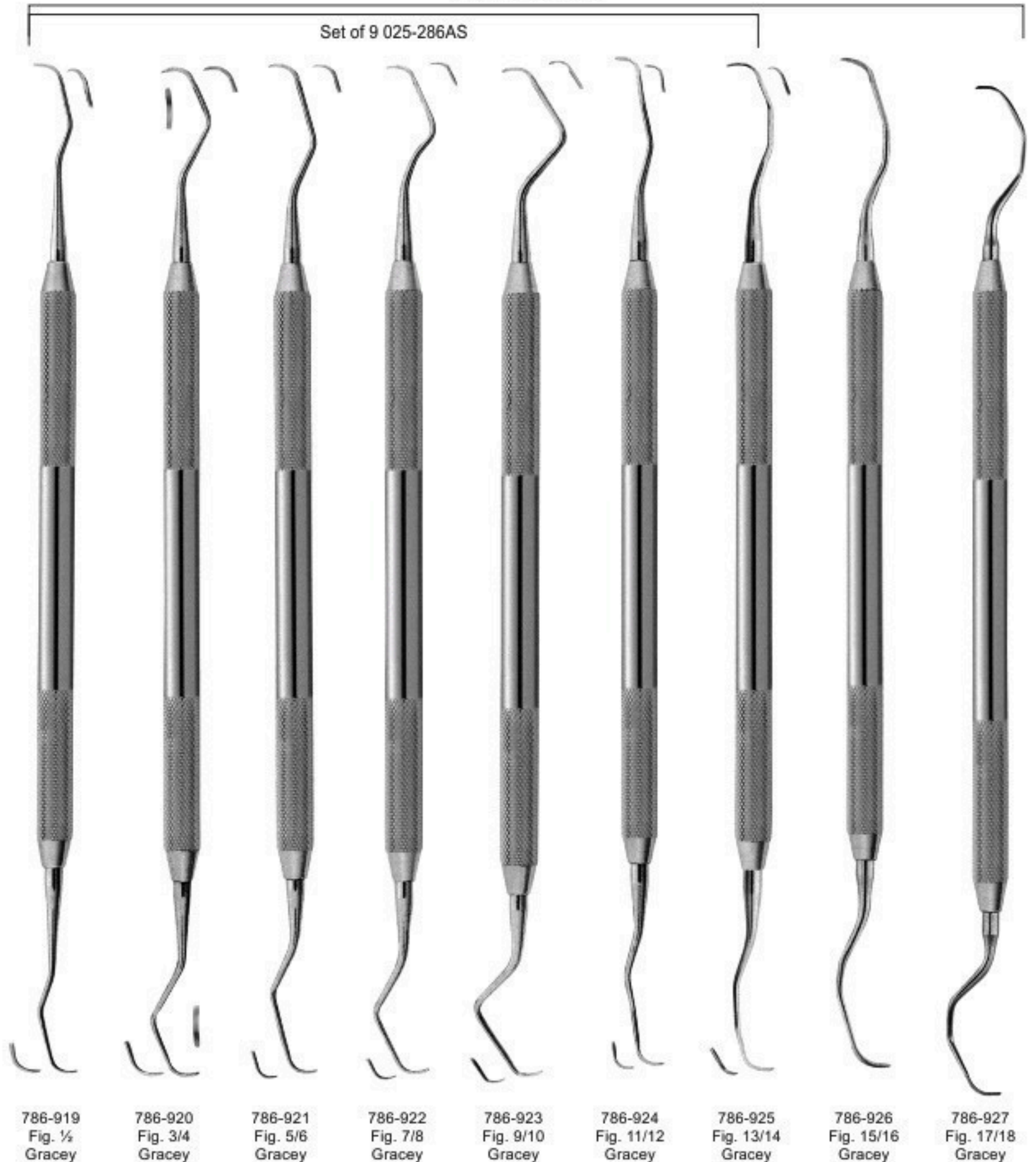



PERIODONTIA INSTRUMENTS

- Инструменты пародонтологические
- Instruments pour la parodontologie
- Instrumente für die Parodontologie

- Інструменти пародонтологічні
- Instrumentos para periodoncia
- الصكوك اللثة

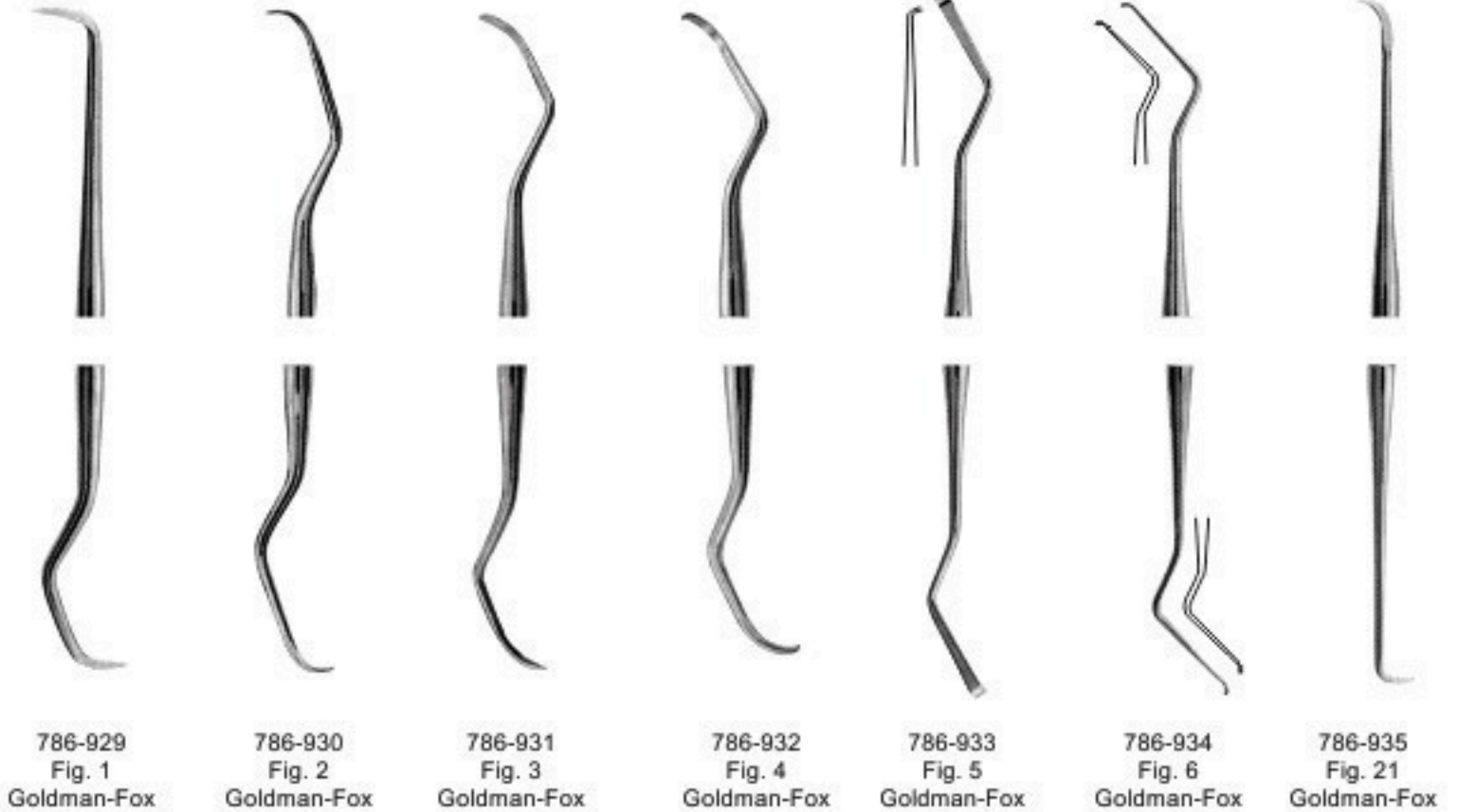



PERIODONTIA INSTRUMENTS

- Инструменты пародонтологические
- Instruments pour la parodontologie
- Instrumente für die Parodontologie

- Інструменти пародонтологічні
- Instrumentos para periodoncia
- الصكوك اللثة



786-943
Fig. 3/7
Hirschfeld



786-944
Fig. 31/32
Jacquette



786-945
Fig. 30/33
Jacquette



786-946
Fig. 34/35
Jacquette



786-947
Fig. 37/38
Jacquette



786-948
Fig. U15/33
Towner Jacquette



786-949
Fig. U15/30
Towner Jacquette



786-950
Fig. H5/33



786-951
Fig. H6/H7



786-952
Fig. 2/3
Taylor



786-953
Fig. 204



786-954
Fig. 204S

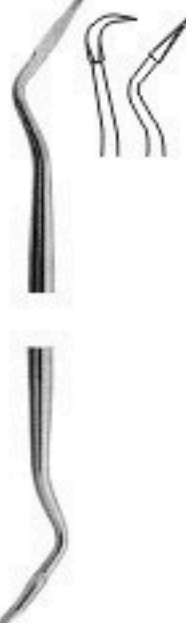

786-955
Fig. 2/3

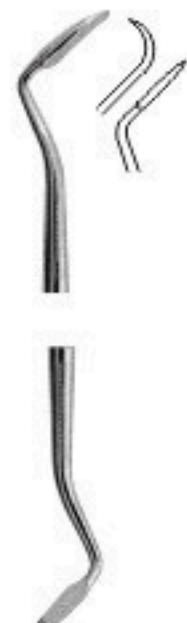

786-956
Fig. 6
Crane-Kaplan



786-957
Fig. 7/8
Younger-Good



786-958
Fig. 1/2



PERIODONTIA INSTRUMENTS

- Инструменты пародонтологические
- Instruments pour la parodontologie
- Instrumente für die Parodontologie
- Инструменти пародонтологічні
- Instrumentos para periodoncia
- الصكوك اللثة

Scalers



786-960
Fig. 31



786-961
Fig. 32



786-962
Fig. 34



786-963
Fig. 35



786-964
Fig. H5
Hygienist



786-965
Fig. H6
Hygienist



786-966
Fig. H7
Hygienist



786-967
Fig. 1



786-968
Fig. 1L
Left



786-969
Fig. 1R
Right



786-970
Fig. 2L
left



786-971
Fig. 2R
Right



786-972
Fig. U15
Towner



786-973
zerfing-Chisel



786-974
Fig. 1
(15K) Kirkland



786-975
Fig. 2
(16K) Kirkland



786-976
Fig. 1
Orban



786-977
Fig. 2
Orban



786-978
Fig. 1
TG Chisel



786-979
Fig. 2
TG Chisel

786-959
Fig. 33



CEMENT SPATULAS

- Шпатели для цемента
- Шпателі для цементу
- Spatules à ciment
- Espátulas para cemento
- ملاعق الأسمنت

Heidemann Separating Spatulas



786-980



786-981



786-982



786-983



786-984



786-985



786-986



786-987



786-988

Fig. 1

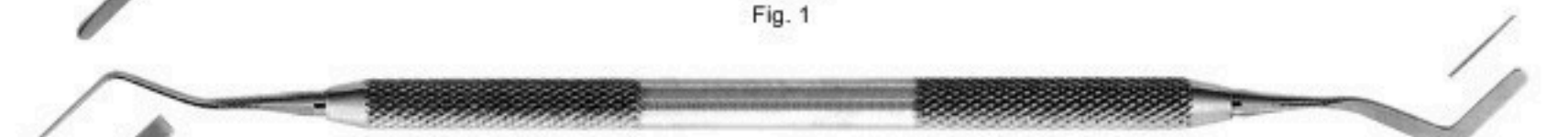

786-989

Fig. 2

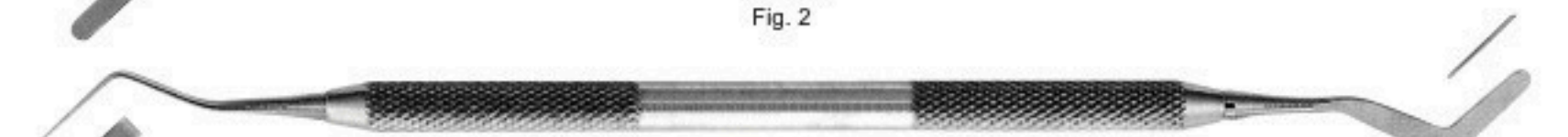

786-990

Fig. 3



WAX & MODELLING CARVERS

- Воск і моделювання Різьбярі
- Wax & Modelling sculpteurs
- Wax Modelado y tallistas

- Воск и моделирования Резчики
- Cera e modellazione Carvers
- الشمع ونمذجة تقطيع

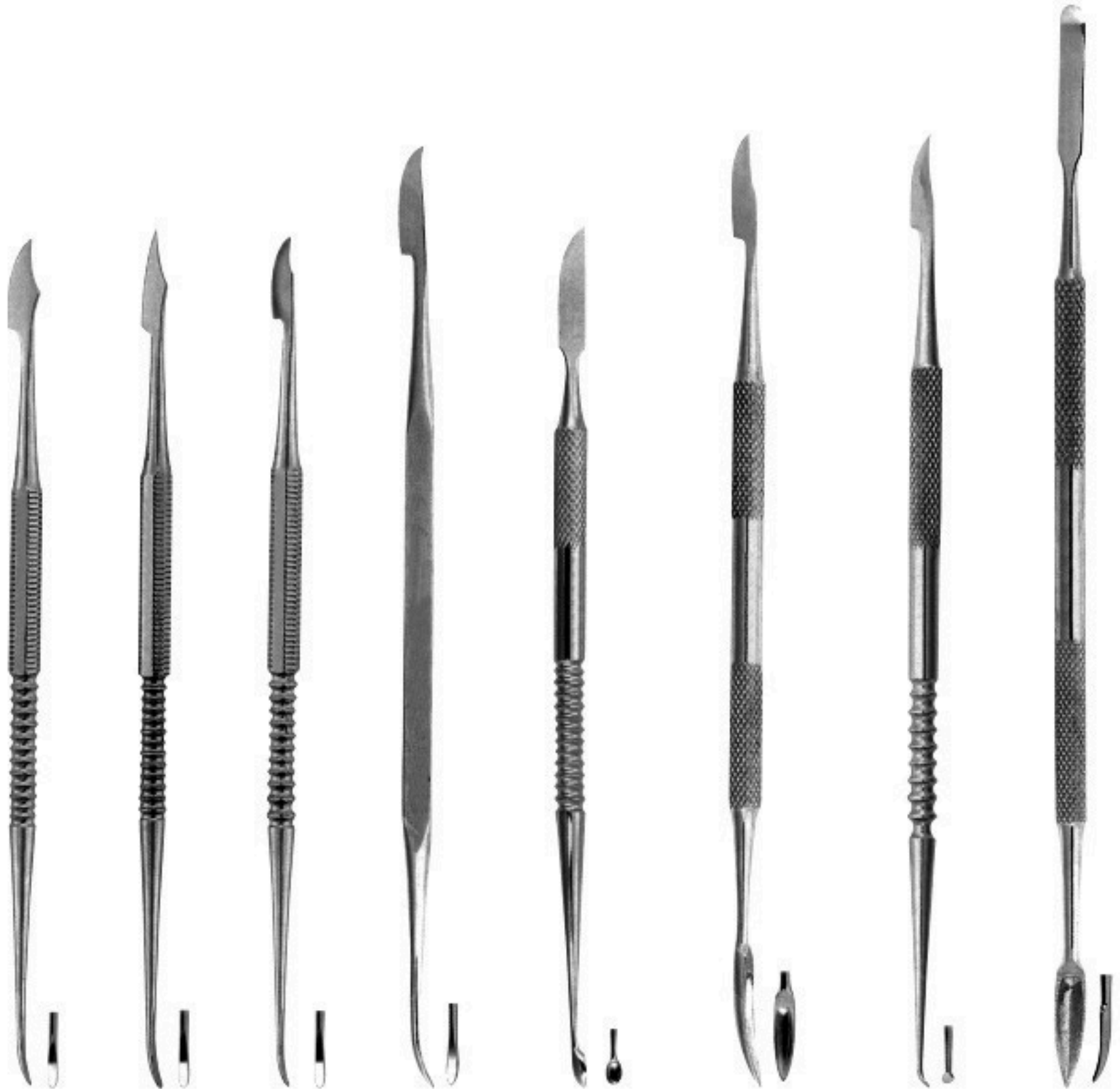

786-991
Zahle

786-992
Zahle

786-993
Zahle

786-994
Hylin-sacred

786-995
Hylin-Ceramica

786-996
Hylin

786-997
Hylin-Le Cron

786-998
Sacred



WAX & MODELLING CARVERS

- Віск і моделювання Різьбярі
- Wax & Modelling sculpteurs
- Wax Modelado y tallistas

- Воск и моделирования Резчики
- Cera e modellazione Carvers
- الشمع ونمذجة تقطيع

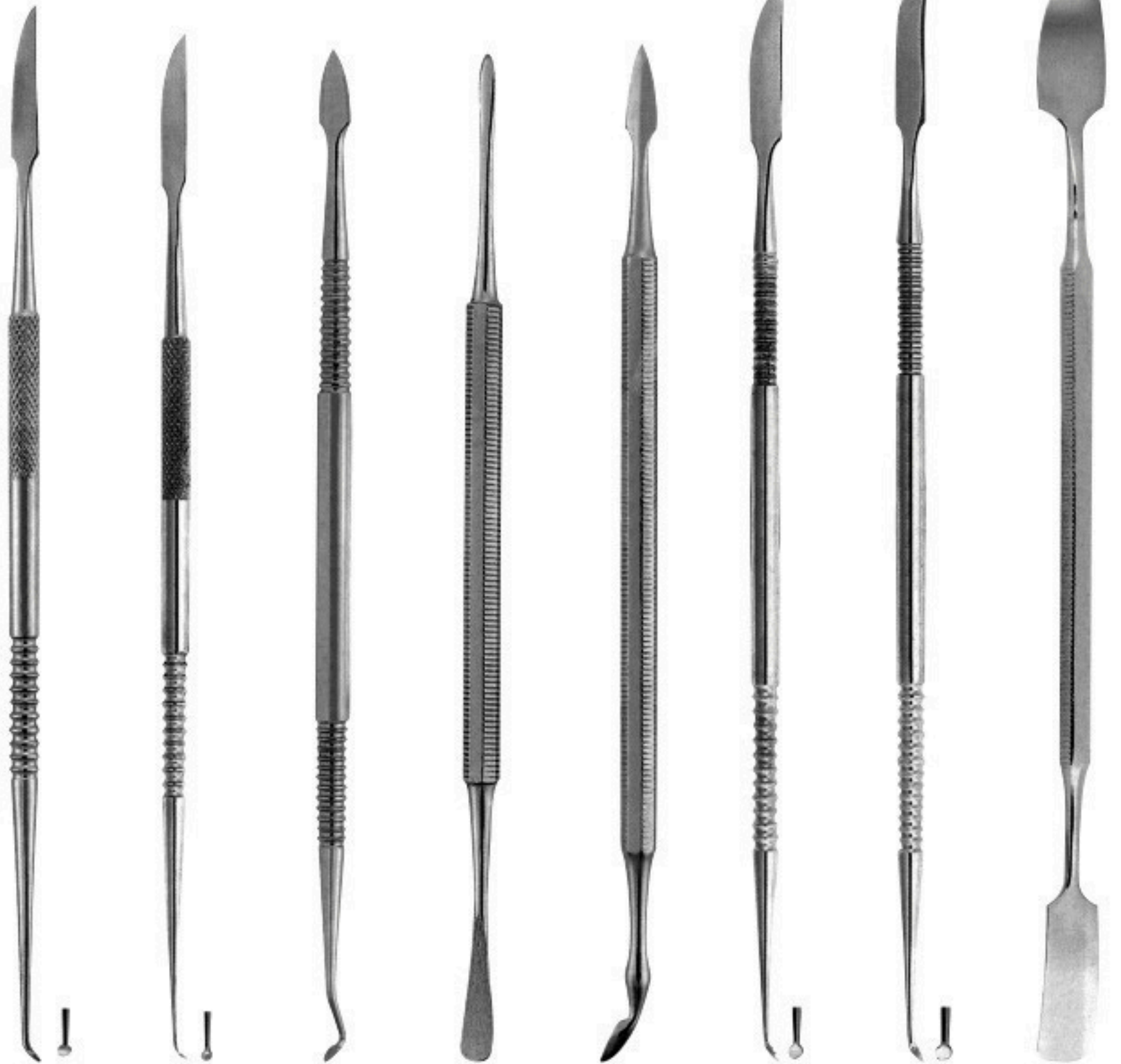

786-999
Le Cron

786-1000
Le Cron

786-1001
Vehe

786-1002
Beale

786-1003
Roach

786-1004
Le Cron

786-1005
Le Cron

786-1006
Gritman



WAX & MODELLING CARVERS

- Віск і моделювання Різьбярі
- Wax & Modelling sculpteurs
- Wax Modelado y tallistas

- Воск и моделирования Резчики
- Cera e modellazione Carvers
- الشمع ونمذجة تقطيع



786-1007
Fig. 1
P.K Thomas



786-1008
Fig. 2
P.K Thomas



786-1009
Fig. 3
P.K Thomas

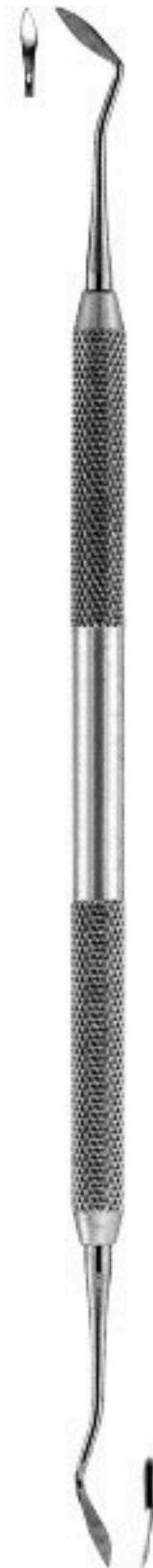

786-1010
Fig. 4
P.K Thomas

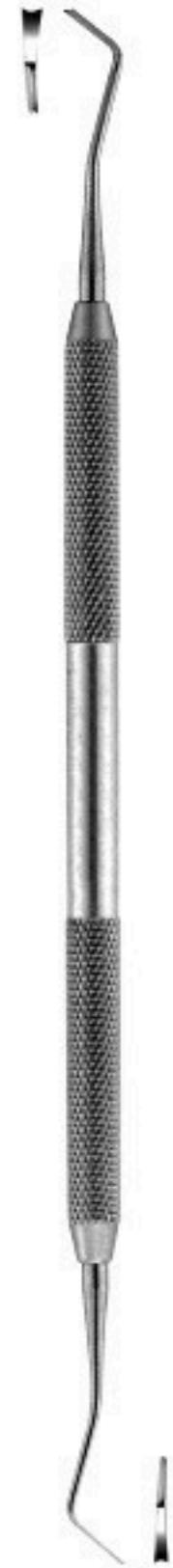

786-1011
Fig. 5
P.K Thomas



WAX & MODELLING CARVERS

- Віск і моделювання Різьбярі
- Wax & Modelling sculpteurs
- Wax Modelado y tallistas

- Воск и моделирования Резчики
- Cera e modellazione Carvers
- الشمع ونمذجة تقطيع



786-1012
Fig. 1
Fahnenstock
12.5 cm



786-1013
Fig. 1
Lessmann
12.5 cm



786-1014
Fig. 1
Con Scodellino
12.5 cm



786-1015
Fig. 2
Fahnenstock
17 cm



786-1016
Fig. 2
Lessmann
17 cm



786-1017
Fig. 2
Con Scodellino
17 cm



SPATULAS FOR PLASTER & ALGINATE

- Шпатель для штукатурки і альгілату
- Spatules pour plâtre et alginate
- Spatole per gesso e alginato
- Шпатель для штукатурки и альгината
- Espátulas para yeso y alginato
- ملاعق للجص وملح الجيني



786-1018
17 cm



786-1019
Gritman 17 cm



786-1020
19.5 cm



786-1021
21.5 cm



786-1022
20.5 cm



786-1023
19.5 cm



786-1024
20 cm



786-1025
22.5 cm



AMALGAM CARVERS

- Инструменты для реставрации
- Instruments pour amalgame
- Amalgampistolen

- Інструменти для реставрації
- instrumentos para amalgama
- تقطيع الملغم

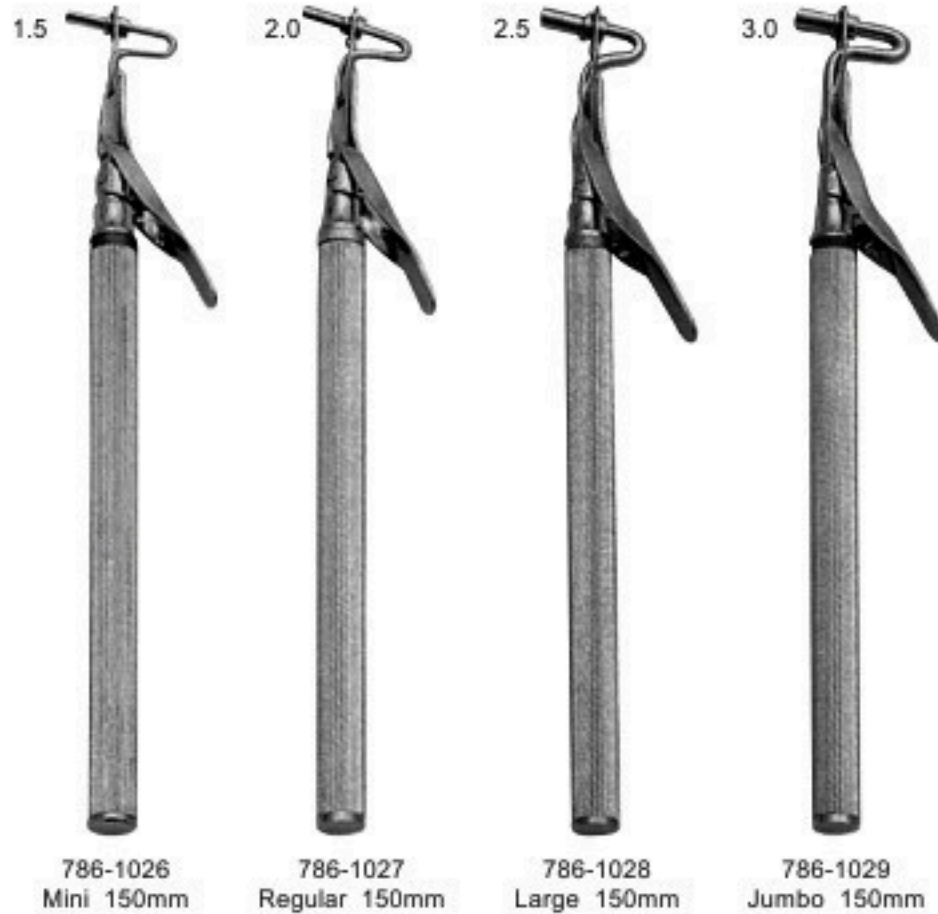

786-1030
Amalgam Well
Stainless Steel

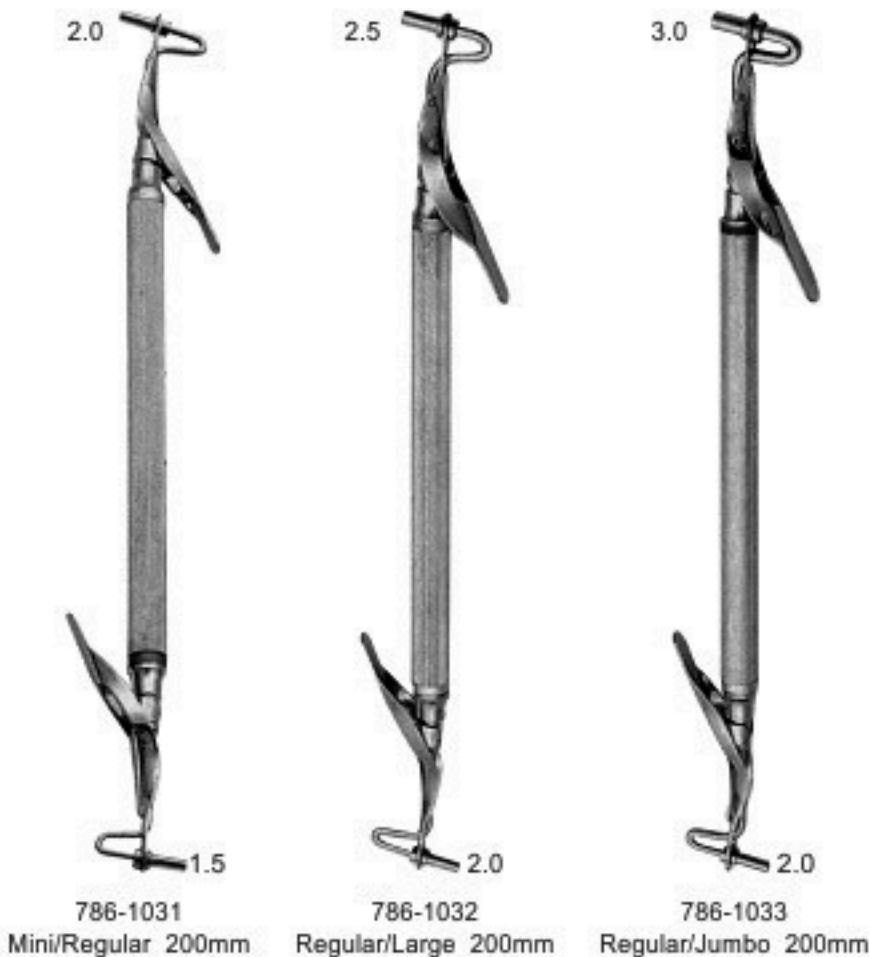



DENTAL CARTRIDGE SYRINGES

- Стоматологічна Шприци картридж
- Seringues à cartouche dentaires
- Jeringas cartuchos dentales
- Стоматологическая Шприцы картридж
- Siringhe cartuccia dentale
- المحاقن خرطوشة الأسنان



786-1037
Intraligmentary Syringe
1,8 ml



786-1038
Cartridge Syringe
2,2 ml
1,8 ml



786-1039
Aspirated Syringe
1,8 ml



786-1040
Aspirated Syringe
1,8 ml



786-1041
Aspirated Syringe
1,8 ml



CHIP BLOWERS, WATER SYRINGES

- Стружкоотсоси, Вода Шприци
- Souffleuse à puce, seringues d'eau
- Sopladores Chip, Jeringas Agua

- Стружкоотсосы, Вода Шприцы
- Soffiatrice trucioli, siringhe acqua
- المنافيخ رقائق، والمحاقن المياه

Napkin Holder, Film Holder



786-1042
Chip Blower



786-1043



786-1044



786-1045



786-1046
Film Holder for
10 Films
786-1047
6 Films
786-1048
14 Films



786-1049
Water Syringe



786-1050
Water Syringe



786-1051
Napkin Holder with Plastic Band

786-1052
Napkin Holder with Metal Chain



MATRIX RETAINERS

- Матрицедержатели
- Porte Matrices
- Matrizenspanner

- Матрицеутримувачи
- Porta Matrices
- مصفوفة الخدم



786-1053 - 5mm
786-1054 - 6mm
786-1055 - 7mm
Ivory 8



786-1056
Ivory 8 N



786-1057
Ivory 8



786-1058
Siqveland-Narrow
786-1059
Siqveland-Wide



786-1060
Fig. 1
Tofflemire-Universal



786-1061
Fig. 3
Tofflemire-Senior



786-1062
Fig. 2
Tofflemire-Junior



786-1063
Didner 8 P



786-1064
Ivory 12



786-1065
Ivory 1



786-1066
Ivory



CROWN INSTRUMENTS

- Инструменты для удаления коронок
- Arrache-couronnes
- Teleskopkronenzangen

- Инструменти для видалення коронок
- Arranca-corona
- مزيلات التاج



Straight, Saw edge

786-1067
Fig. 1
10.5 cm

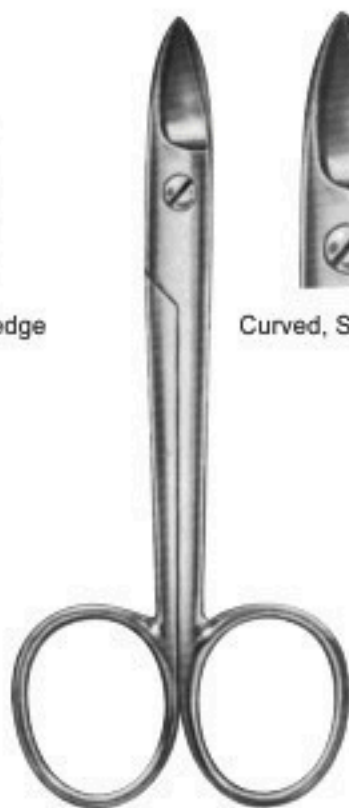

Curved, Saw edge

786-1068
Fig. 1
10.5 cm



786-1069
Universal
12 cm

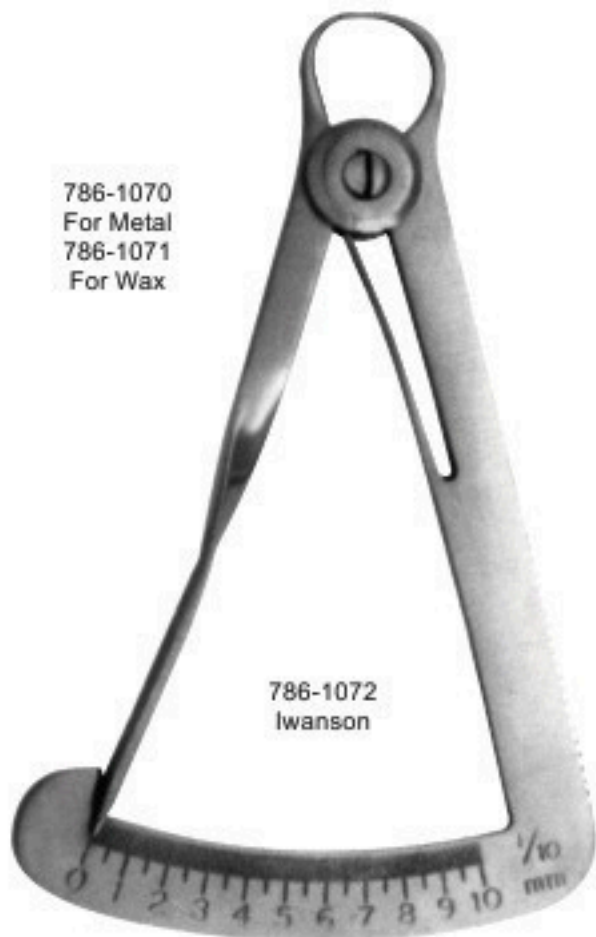

786-1070
For Metal
786-1071
For Wax

786-1072
Iwanson



Universal

786-1073
Fig. 3
Crown Spreader



786-1074
Boley
14 cm



CROWN INSTRUMENTS

- Инструменты для удаления коронок
- Arrache-couronnes
- Teleskopkronenzangen

- Инструменти для видалення коронок
- Arranca-corona
- مزيلات التاج

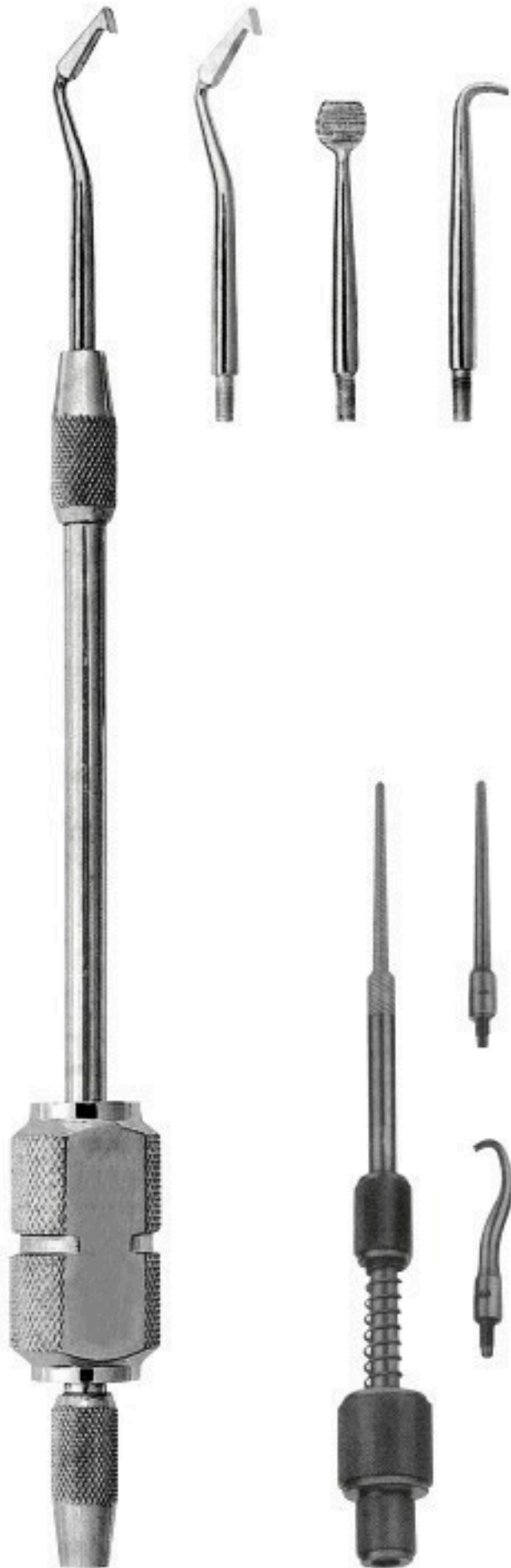

786-1076
Crown removers



786-1077
Crown removers

with 5 Points



786-1075
Crown removers
Automatic



786-1078
Crown removers



CROWN INSTRUMENTS

- Инструменты для удаления коронок
- Arrache-couronnes
- Teleskopkronenzangen
- Инструменти для видалення коронок
- Arranca-corona
- مزيلات التاج

Plastic Cutting Plier



786-1079
15 cm

Articulating
Paper Forceps



786-1080
Miller
15 cm



786-1081
Crown Spreader

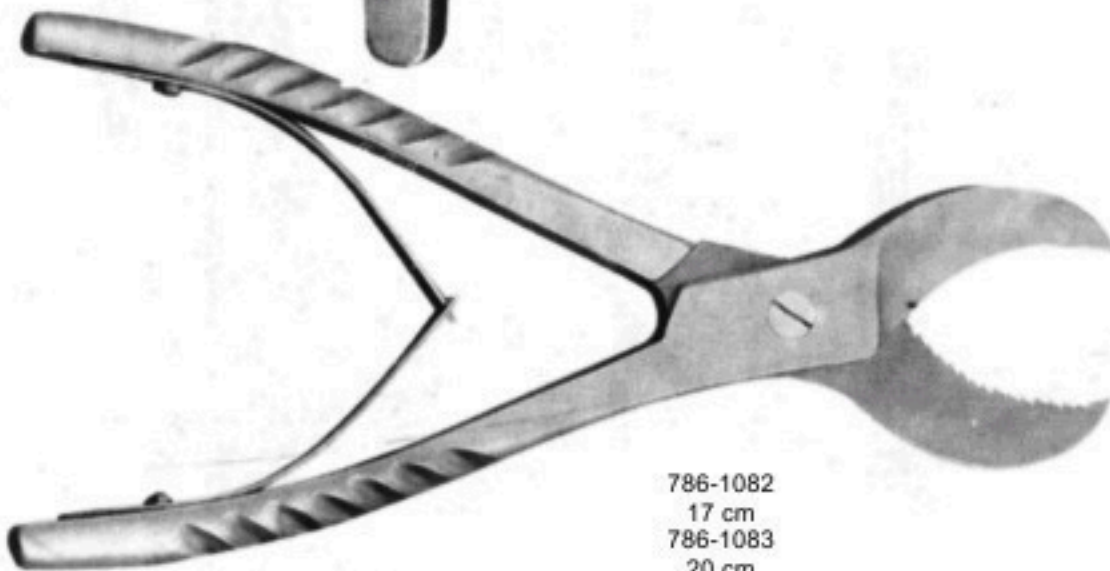

786-1082
17 cm
786-1083
20 cm

Plaster Cutting Pliers



STAINLESS STEEL IMPRESSION TRAYS

- Вираження лотки з нержавіючої сталі
- Впечатление лотки из нержавеющей стали
- Inoxydable Porte-empreintes en acier
- Acciaio Impronte d'acciaio
- Cubetas de impresión de acero inoxidable
- الفولاذ المقاوم للصدأ صواني الظهور

Made of 18/8 Stainless Steel

Solid Partial Set of 10
225-001WA

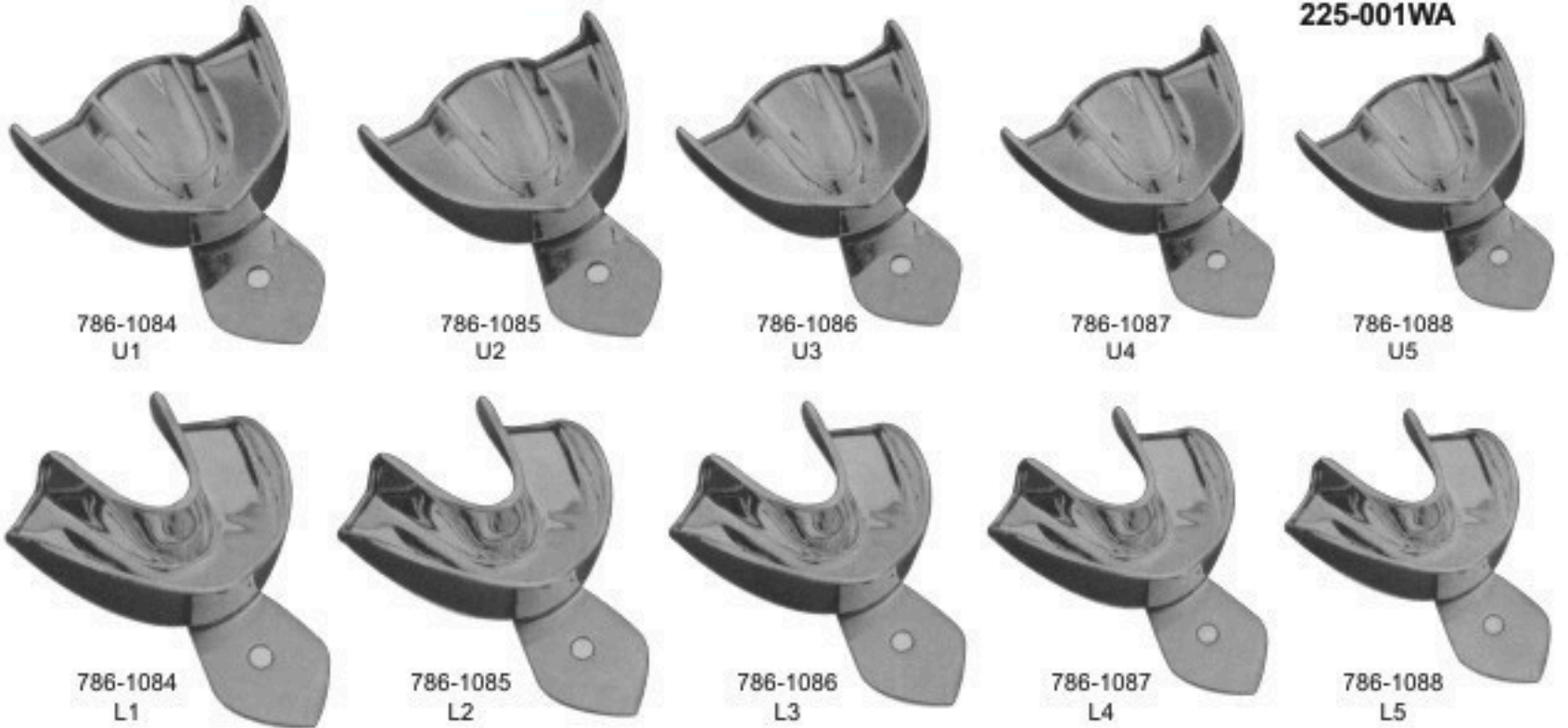

All the above impression trays are available in these 5 sizes

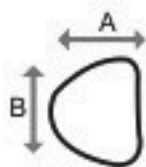

UPPER	U 1	U 2	U 3	U 4	U 5
	A	62	60	53	54
B	85	75	73	69	68

All Dimension are in mm

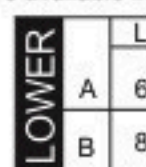

LOWER	L 1	L 2	L 3	L 4	L 5
	A	62	60	53	54
B	85	75	73	69	68

All Dimension are in mm

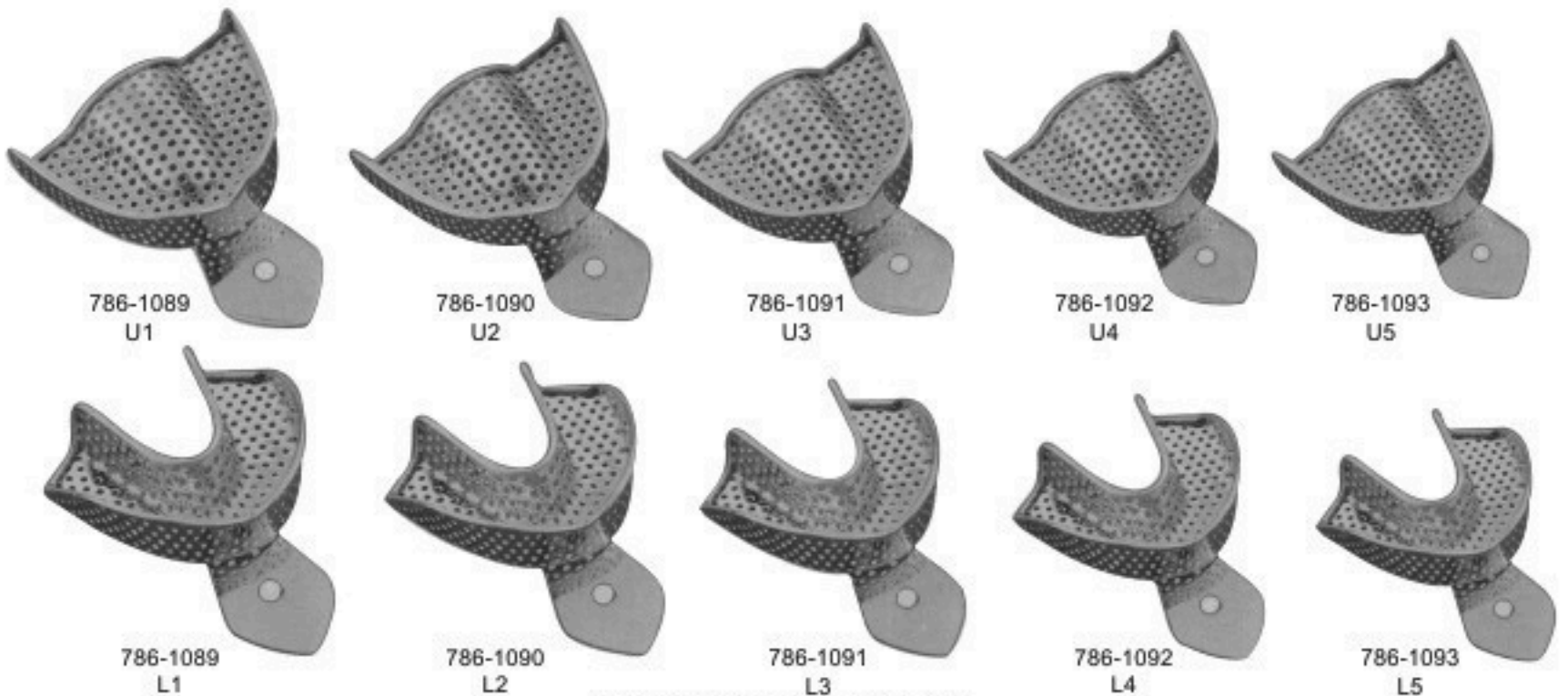

Perforated Partial Set of 10
225-010WA



STAINLESS STEEL IMPRESSION TRAYS

- Вираження лотки з нержавіючої сталі
- Inoxydable Porte-empreintes en acier
- Cubetas de impresión de acero inoxidable
- Впечатление лотки из нержавеющей стали
- Acciaio Impronte d'acciaio
- الفولاذ المقاوم للصدأ صواني الظهور

Made of 18/8 Stainless Steel

Solid Full Denture Set of 8 225-011WA



All the above impression trays are available in these 4 sizes

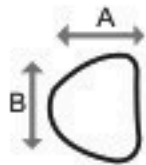

UPPER		XL	L	M	S
	A	70	67	64	60
B	79	76	70	73	

All Dimension are in mm

LOWER		XL	L	M	S
	A	64	64	60	57
B	86	70	73	70	

All Dimension are in mm

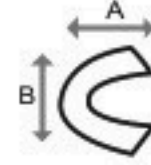

Perforated Full Denture Set of 8 225-018WA



STAINLESS STEEL IMPRESSION TRAYS

- Вираження лотки з нержавіючої сталі
- Inoxydable Porte-empreintes en acier
- Cubetas de impresión de acero inoxidable
- Впечатление лотки из нержавеющей стали
- Acciaio Impronte d'acciaio
- الفولاذ المقاوم للصدأ صواني الظهور

Made of 18/8 Stainless Steel

Solid Set of 6
225-019S



786-1102
U1



786-1103
U2



786-1104
U3

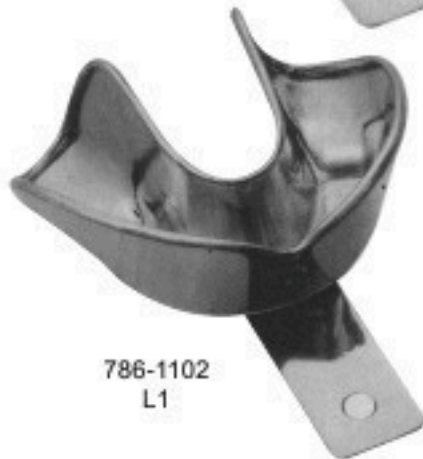

786-1102
L1



786-1103
L2



786-1104
L3

All the above impression trays are available in these 3 sizes

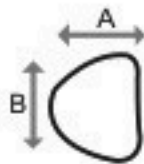

UPPER		U 1	U 2	U 3
	A	67	64	57
B	81	71	70	

All Dimension are in mm

LOWER		L 1	L 2	L 3
	A	60	57	54
B	81	79	76	

All Dimension are in mm

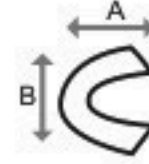

786-1105
U1



786-1106
U2



786-1107
U3



786-1105
L1



786-1106
L2



786-1107
L3

Perforated Set of 6
225-024S



STAINLESS STEEL IMPRESSION TRAYS

- Враження лотки з нержавіючої сталі
- Inoxydable Porte-empreintes en acier
- Cubetas de impresión de acero inoxidable
- Впечатление лотки из нержавеющей стали
- Acciaio Impronte d'acciaio
- الفولاذ المقاوم للصدأ صواني الظهور

Made of 18/8 Stainless Steel



786-1108
Lower

English Pattern

**Set of 8
225-025S**

Mesh Type



786-1108
Upper

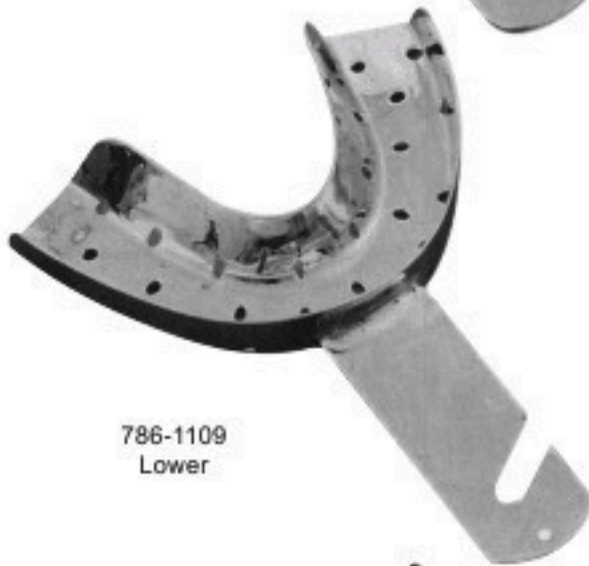

786-1109
Lower

**Set of 8
225-026S**

Punched Type



786-1109
Upper



786-1110
Lower

**Set of 8
225-027S**

Solid Type



786-1110
Upper

All the above impression trays are available in these 3 sizes

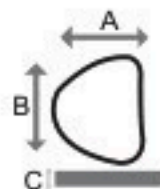

UPPER	Size	A	B	C
	0	67	50	12
	1	72	51	13
	2	78	55	15
	3	80	58	15

All Dimension are in mm

LOWER	Size	A	B	C
	0	70	50	14
	1	77	51	15
	2	79	55	15
	3	80	60	17

All Dimension are in mm

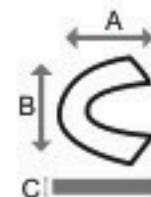



STAINLESS STEEL IMPRESSION TRAYS

- Вираження лотки з нержавіючої сталі
- Inoxydable Porte-empreintes en acier
- Cubetas de impresión de acero inoxidable
- Впечатление лотки из нержавеющей стали
- Acciaio Impronte d'acciaio
- الفولاذ المقاوم للصدأ صواني الظهور

Made of 18/8 Stainless Steel

Solid Full Denture Set of 8
225-028S

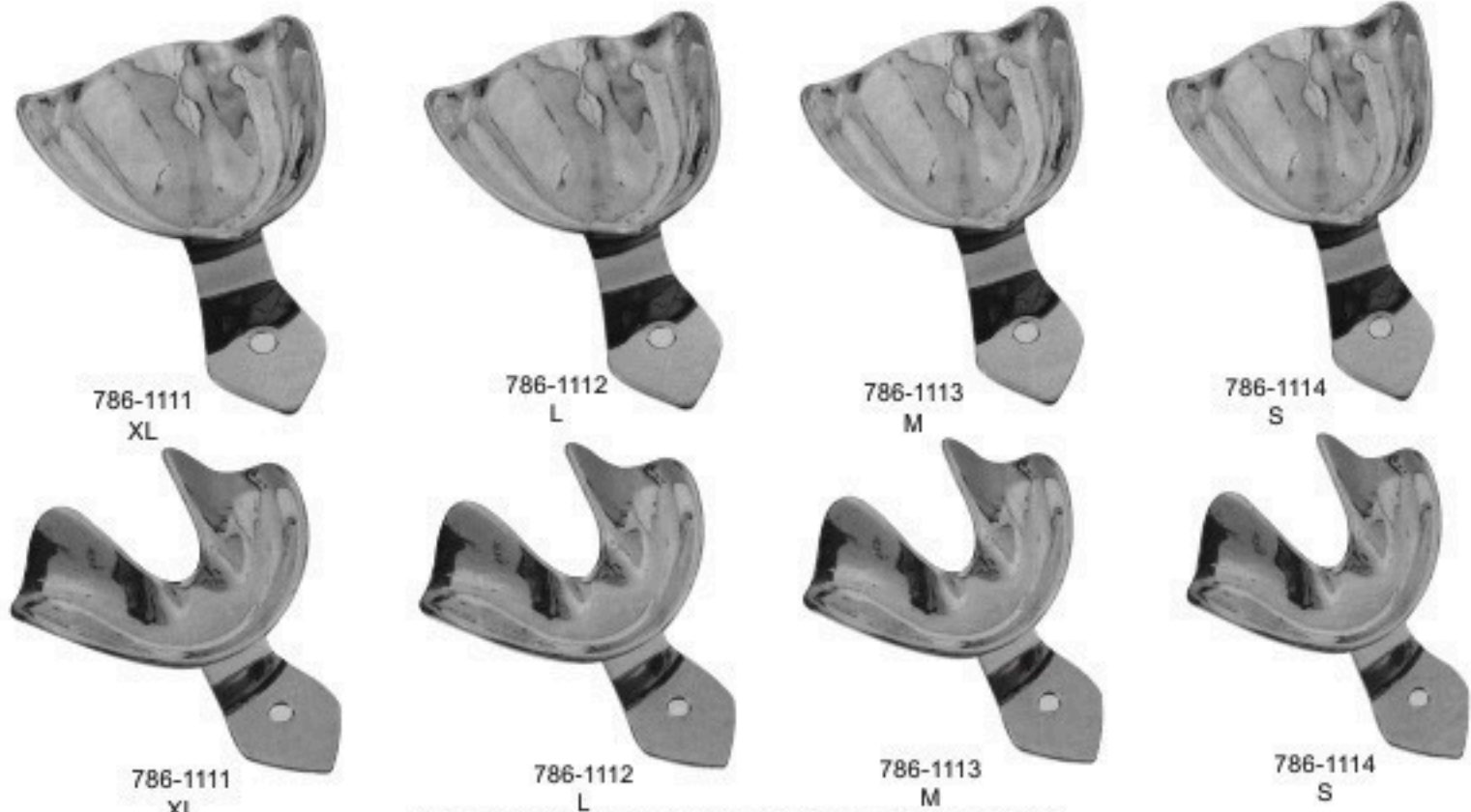

786-1111
XL

786-1112
L

786-1113
M

786-1114
S

786-1111
XL

786-1112
L

786-1113
M

786-1114
S

All the above impression trays are available in these 3 sizes

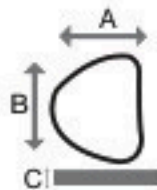

UPPER		XL	L	M	S
	A	70	67	64	60
B	79	76	70	73	

All Dimension are in mm

LOWER		XL	L	M	S
	A	64	64	60	57
B	86	70	73	70	

All Dimension are in mm

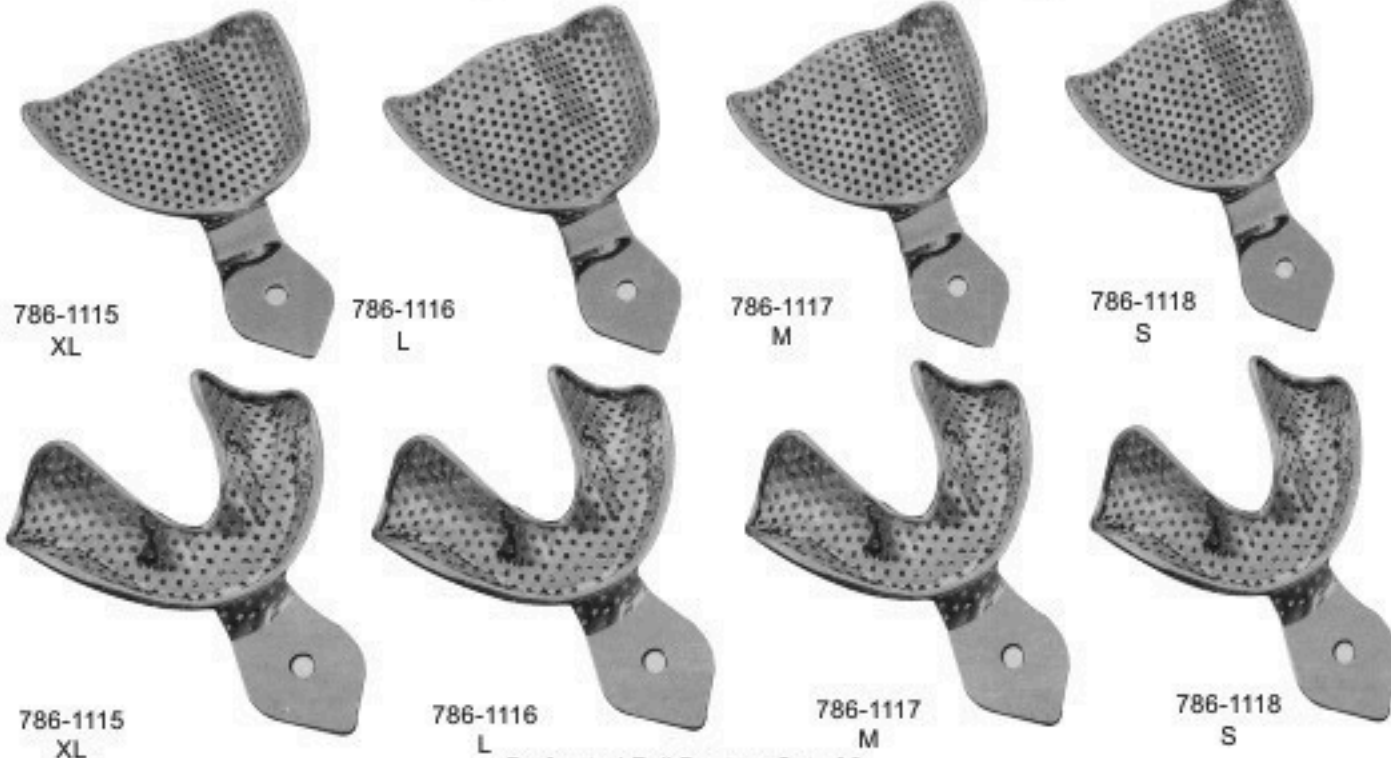
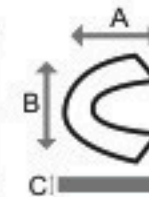

786-1115
XL

786-1116
L

786-1117
M

786-1118
S

786-1115
XL

786-1116
L

786-1117
M

786-1118
S

Perforated Full Denture Set of 8
225-035S



STAINLESS STEEL IMPRESSION TRAYS

- Вираження лотки з нержавіючої сталі
- Inoxydable Porte-empreintes en acier
- Cubetas de impresión de acero inoxidable
- Впечатление лотки из нержавеющей стали
- Acciaio Impronte d'acciaio
- الفولاذ المقاوم للصدأ صواني الظهور

Made of 18/8 Stainless Steel



786-1119
U0



786-1120
U1



786-1121
U2



786-1122
U3



786-1119
L0



786-1120
L1



786-1121
L2



786-1122
L3

Upper sizes 0,1,2,3,
Depth of the tray 15,9 mm
Height of palate 12,5 mm

Lower sizes 0,1,2,3,
Depth of the tray 12,9 mm



786-1123
U0



786-1124
U1



786-1125
U2

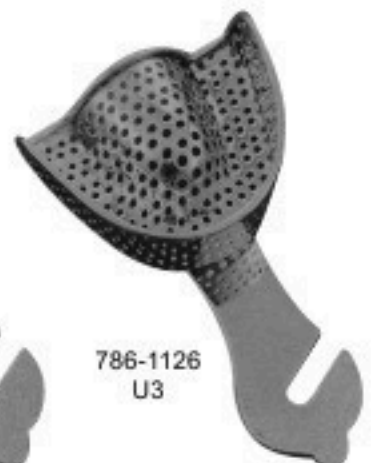

786-1126
U3



786-1123
L0



786-1124
L1



786-1125
L2



786-1126
L3

Perforated Full Denture Set of 8
225-043S



STAINLESS STEEL IMPRESSION TRAYS

- Вираження лотки з нержавіючої сталі
- Inoxydable Porte-empreintes en acier
- Cubetas de impresión de acero inoxidable
- Впечатление лотки из нержавеющей стали
- Acciaio Impronte d'acciaio
- الفولاذ المقاوم للصدأ صواني الظهور

Made of 18/8 Stainless Steel

Impression Tray For Crown & Bridge Work

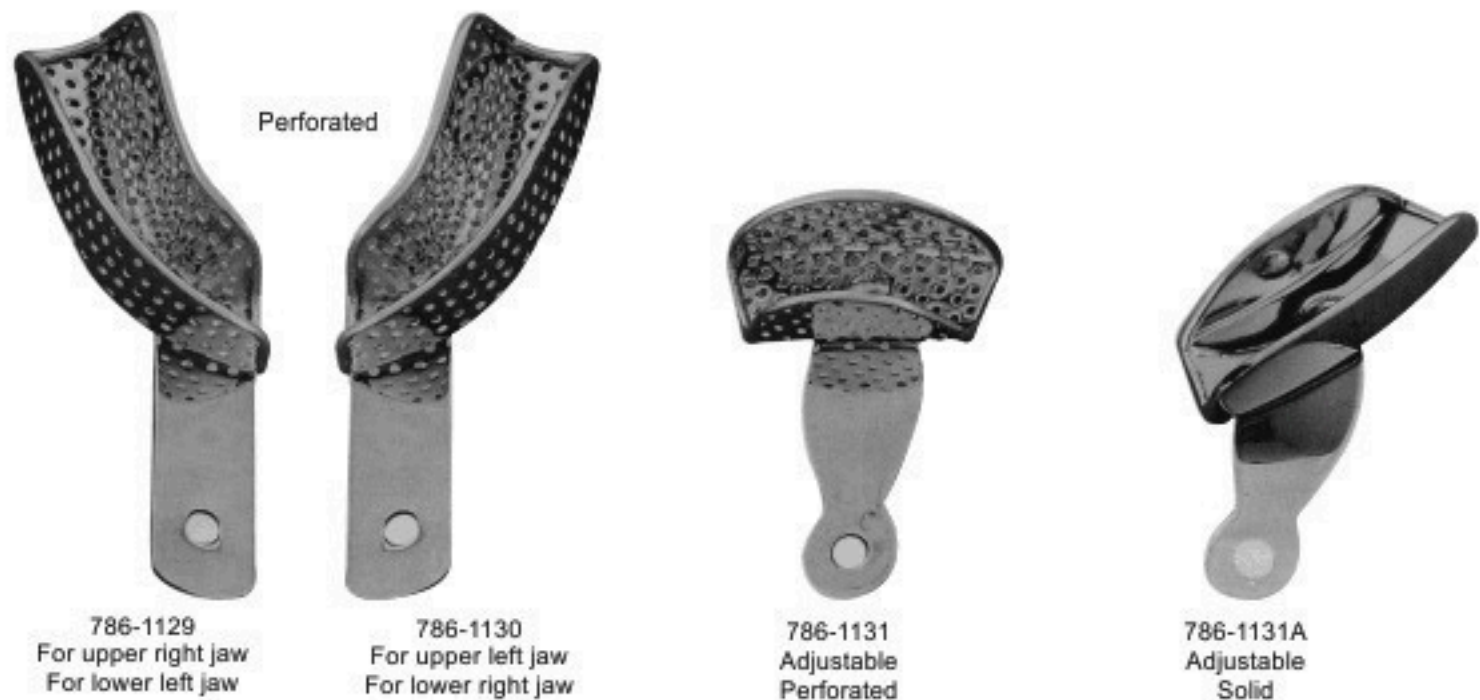

Available in 4 Sizes

- 1..... 44 mm
- 2..... 55 mm
- 3..... 60 mm
- 4..... 65 mm

Also available in Solid pattern



STAINLESS STEEL INSTRUMENT TRAYS

- Лотки з нержавіючої інструментальної сталі
- Inoxidable plateaux d'instruments en acier
- Acciaio Strumento Vassoi d'acciaio
- Лотки из нержавеющей инструментальной стали
- Bandejas de acero inoxidable instrumento
- الفولاذ المقاوم للصدأ صوتاني الصك

Made of 18/8 Stainless Steel

786-1132

Lid; dimensions mm,288x187x29

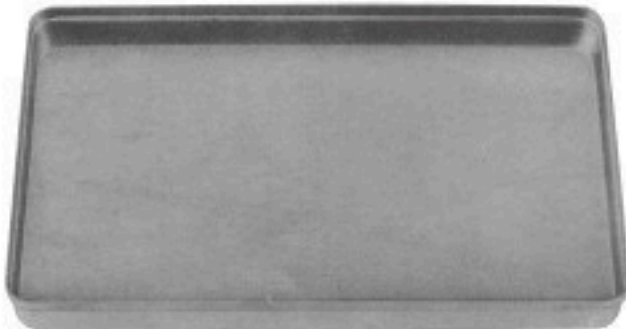

786-1132S

Complete instrument tray with perforated base, lid & insert frame for 16 instrument

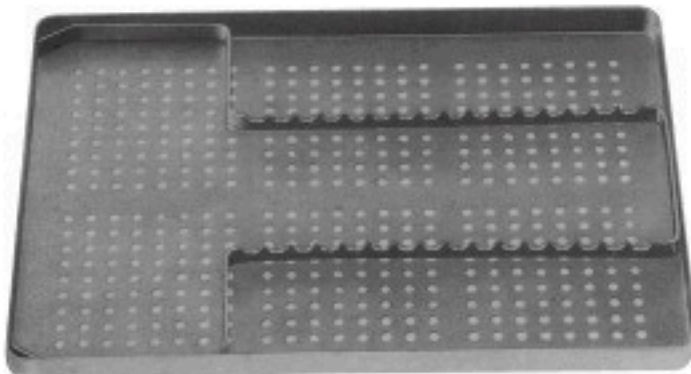

786-1133

Perforated base; dimensions 284x183x17 mm
786-1125S

Complete instrument tray with solid base, lid & insert frame for 16 instrument

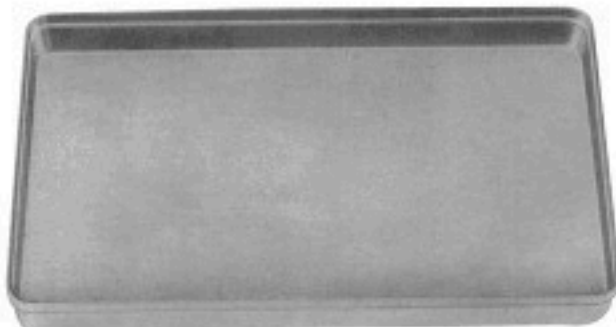

786-1134

Lid; dimensions 288x187x29 mm

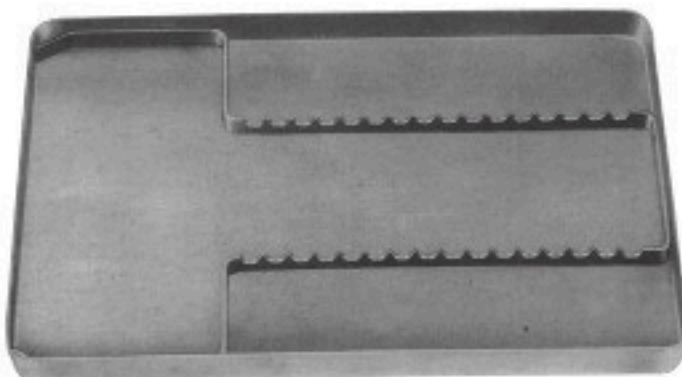

786-1135

Solid base; dimensions 284x183x17 mm

786-1136

Lid; dimensions mm,288x187x29

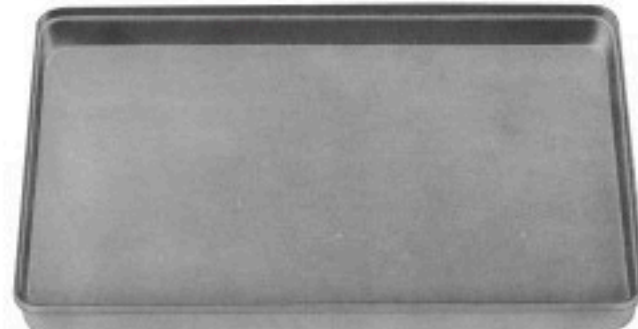

786-1137S

Complete instrument tray with perforated base, lid & insert frame for 23 instrument

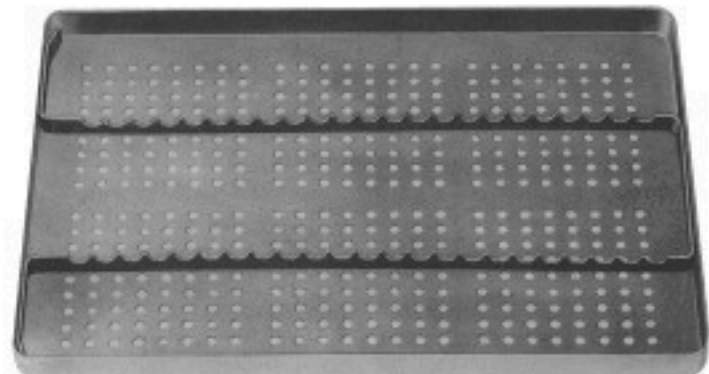

786-1137

Perforated base; dimensions 284x183x17 mm
786-1139S

Complete instrument tray with solid base, lid & insert frame for 23 instrument



786-1138

Lid; dimensions 288x187x29 mm

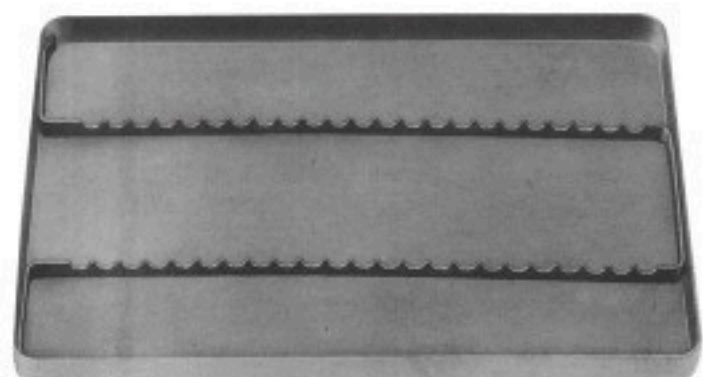

786-1139

Solid base; dimensions 284x183x17 mm



STAINLESS STEEL INSTRUMENT TRAYS

- Лотки з нержавіючої інструментальної сталі
- Inoxidable plateaux d'instruments en acier
- Acciaio Strumento Vassoi d'acciaio
- Лотки из нержавеющей инструментальной стали
- Bandejas de acero inoxidable instrumento
- الفولاذ المقاوم للصدأ صوتاني الصك

Made of 18/8 Stainless Steel

Scalers Tray

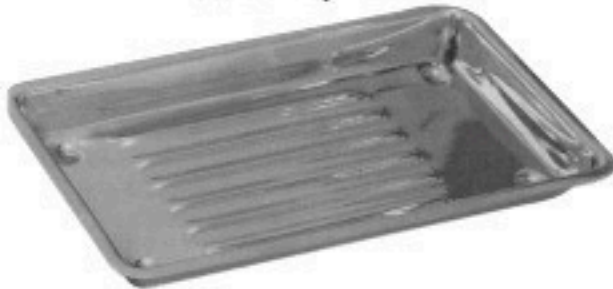

786-1140



786-1141
6" x 10"
without lid



786-1142
6" x 8"
with lid



786-1143
6" x 8"
8" x 10"
10" x 12"
with lid



786-1144



786-1145
Endodontic box
Also available in Solid pattern

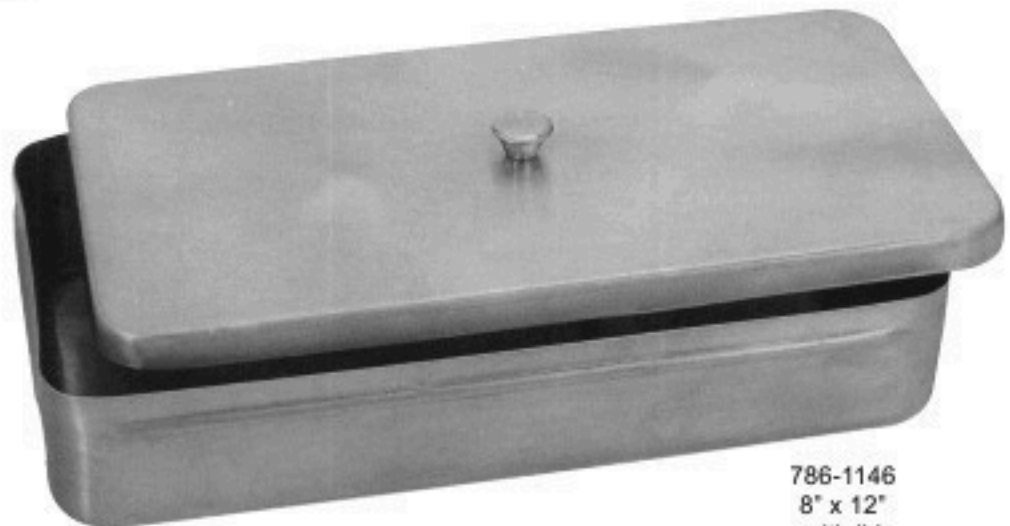

786-1146
8" x 12"
with lid



STAINLESS STEEL INSTRUMENT TRAYS

- Лотки з нержавіючої інструментальної сталі
- Inoxidable plateaux d'instruments en acier
- Acciaio Strumento Vassoi d'acciaio
- Лотки из нержавеющей инструментальной стали
- Bandejas de acero inoxidable instrumento
- الفولاذ المقاوم للصدأ صوتاني الصك

Made of 18/8 Stainless Steel



786-1147

Deep

2.25" x 2"
 4.75" x 2"
 5.5" x 2.5"
 6.25" x 2.75"
 7" x 3.5"

Kidney trays



786-1148
 12" - 10" - 8" - 6"



786-1149
 6" x 9" - 8" x 12"

Shallow



786-1150
 10" x 10"



786-1151
 Cotton holder

Round bowls



80x35 mm
 125x60 mm

786-1152



786-1153
 Spirit lamp



786-1154
 Spirit lamp

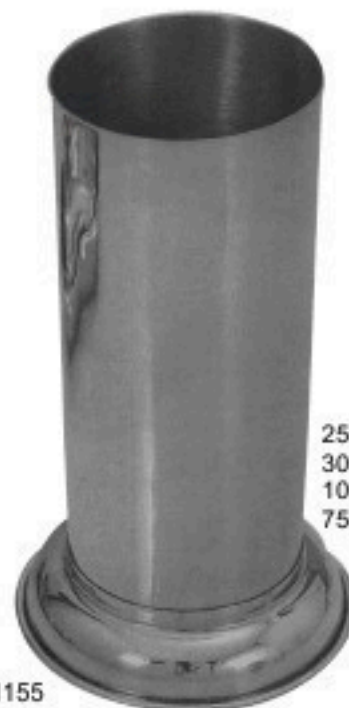

25 x 80 mm
 30 x 100 mm
 100 x 200 mm
 75 x 173 mm

786-1155
 Forcep Jar



RUBBER DAM CLAMPS

- Кламмера для коффердама
- Crampons pour digue
- Kofferdam Klammern

- Кламмера для коффердама
- Grapas para dique de caucho
- المشابك السد المطاط

Molar Clamps Winged



786-1156
Fig. 30



786-1157
Fig. 31



786-1158
Fig. 51



786-1159
Fig. 138



786-1160
Fig. 139



786-1161
Fig. 15



786-1162
Fig. 18



786-1163
Fig. 24



786-1164
Fig. 25



786-1165
Fig. 26



786-1166
Fig. 28

Bicuspid Clamps Winged



786-1167
Fig. 206



786-1168
Fig. 207



786-1169
Fig. 208



786-1170
Fig. 209



786-1171
Fig. 22



786-1172
Fig. 27



786-1173
Fig. 29

Molar Clamps Winged



786-1174
Fig. 26A



786-1175
Fig. 28A



786-1176
Fig. 30A



786-1177
Fig. 31A



786-1178
Fig. 51A

Bicuspid Clamps Winged



786-1179
Fig. 27



786-1180
Fig. 29



786-1181
Fig. 61

Molar Clamps Winged



786-1182
Fig. 200



786-1183
Fig. 201



786-1184
Fig. 202



786-1185
Fig. 203



786-1186
Fig. 204



786-1187
Fig. 205

Labial Clamps Winged



786-1188
Fig. 210



786-1189
Fig. 211



786-1190
Fig. 212



ORTHODONTIC PLIERS

- ортодонтичні плоскогубці
- Pincers orthodontiques
- Pinze ortodontiche

- ортодонтические плоскогубцы
- Pinze ortodontiche
- كماشة تقويم الأسنان

786-005

How Plier

Firmly hold the bracket tie wing for seating of the band. Carbide serrated tips for non grip. 49.50



786-001

De Bonding Plier

Bracket / Adhesive remove with replaceable tool steel tip. wedge between both edges of the base of the bracket lifting and tooth surface. Easily lifting off the bracket or Bonding material. 49.50

786-006

Jara Back Plier

A Plier for precise bending of wires. Precision grooves ensure accurate bending and closing of loops. Serrated tip for up to .020" wires. 49.50



786-002

Posterior Band Remover Long

The padded tip rest on the Occlusal of the molar and the carbide tipped side removes the bracket or Bonding material. 49.50



786-007

Hard Wire Cutter

Cuts hard wire up to .020" carbide insert for longer life. 49.50



786-003

Posterior Band Remover Small

49.50

786-008

Pin & Ligature Cutter

Standard size lips designed to cut soft wire up to .051". 49.50



786-004

Tweed Loop Forming Plier

3 Size carbide tip allows to make 3 size loops. Can hold wire firmly upto .022" x .028" The other side serrated tip gives non slip grip. 49.50

All Pliers Also Available In Box Joint



ORTHODONTIC PLIERS

- ортодонтичні плоскогубці
- Pincers orthodontiques
- Pinze ortodontiche

- ортодонтические плоскогубцы
- Pinze ortodontiche
- كماشة تقويم الأسنان

786-013

Bird Beak Plier

1/2" Long tip carbide inserted round tip and flat ground tip gives non slip grip for wire up to .030". 49.50



786-009

Angled Direct Bond Bracket Remover

60° Angled tip allows for easy access to difficult anterior and posterior areas. 49.50

786-014

Safety hold, small Distal end Cutter
Narrow and light.
49.50

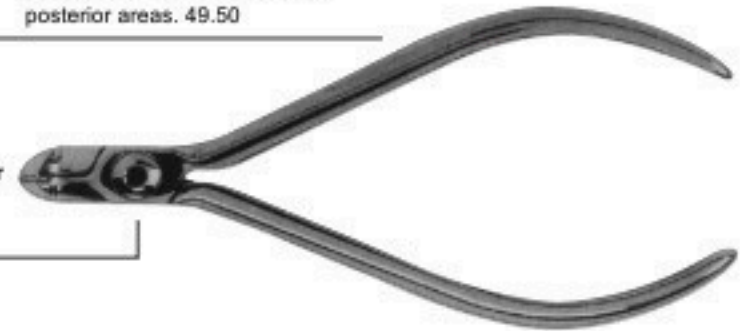

786-010

Weingart Utility Plier

Matching deep serrated pads holds wire firmly at a convex working angle. Tapered narrow lip fits easily between brackets. 49.50



786-015

Safety hold, Distal end Cutter
Carbide tips for longer life and sharpness cuts and hold wire up to .022" x .028". 49.50

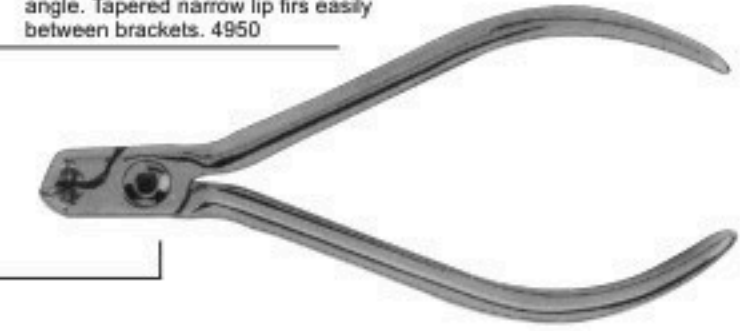

786-011

Three Prong Clasps Adjusting Plier

Rounded jaws close and adjust clasps without niking wire upto .030". 49.50



786-016

Mini Pin & Ligature Cutter
Narrow tips cuts pins, Ligatures and elastic smoothly and soft wire up to .015". 49.50

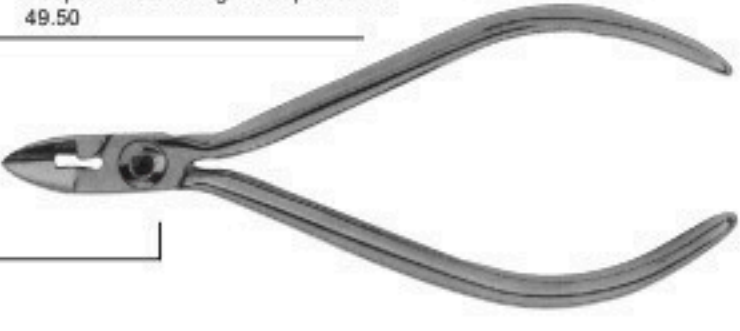

786-012

Light Wire Plier

Wire forming Plier upto .061" the longer tapered beaks make it easier to bend small diameter loops. 3Groves on square tip. 49.50

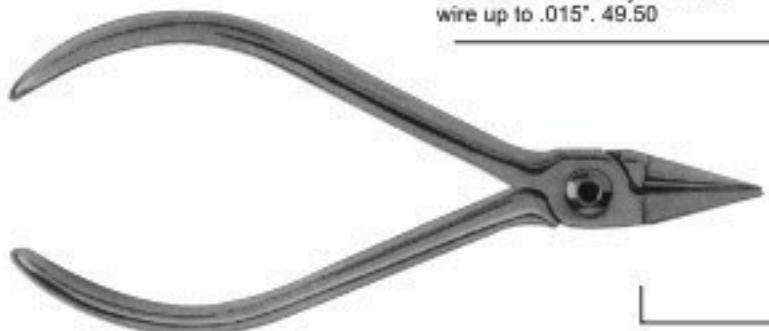

All Pliers Also Available In Box Joint



ORTHODONTIC PLIERS

- ортодонтичні плоскогубці
- Pincers orthodontiques
- Pinze ortodontiche

- ортодонтические плоскогубцы
- Pinze ortodontiche
- كماشة تقويم الأسنان



Weingart style plier
13 cm / 5"

786-1213 Box Joint
786-1214 Screw Joint
786-1215 L-Key Joint
Classical design, rounded tips.
Useful for removal of ceramics.



Rectangular Arch plier
13 cm / 5"

786-1216 Box Joint
786-1217 Screw Joint
786-1218 L-Key Joint
Short jaws, Tweed style, for use
with square or rectangular wires.
Blades parallel at 0.02", 0.51mm opening.



Arch forming &
contouring plier
13 cm / 5"

786-1219 Box Joint
786-1220 Screw Joint
786-1221 L-Key Joint
With 3 grooves,
For wire 0.016", 0.018" & 0.022".



Arch forming plier
13 cm / 5"

786-1222 Box Joint
786-1223 Screw Joint
786-1224 L-Key Joint
Without grooves



Arch contouring plier
13 cm / 5"

786-1225 Box Joint
786-1226 Screw Joint
786-1227 L-Key Joint
for easily forming arches.



Distal wire cutter
15 cm / 5"

786-1228 Box Joint
786-1229 Screw Joint
786-1230 L-Key Joint



Lindblom
13 cm / 5"

786-1231 Box Joint
786-1232 Screw Joint
786-1233 L-Key Joint



Miniature ligature cutter
13 cm / 5"

786-1234 Box Joint
786-1235 Screw Joint
786-1236 L-Key Joint
For soft wires.
ligature wire up to 0.014" (0.36mm)



Hard wire cutter
13 cm / 5"

786-1237 Box Joint
786-1238 Screw Joint
786-1239 L-Key Joint
For cutting orthodontic wires for
fixed techniques any size.
Cuts rectangular wire up to 0.56x0.71mm
and round wire up to 0.51mm



Micro Distal end cutter
13 cm / 5"

786-1240 Box Joint
786-1241 Screw Joint
786-1242 L-Key Joint
With safety hold, cuts arch wires.
Cuts rectangular wire up to 0.56x0.71mm,
round wire up to 0.51mm and
twisted wire up to 0.41mm



45° Ligature cutter
13 cm / 5"

786-1243 Box Joint
786-1244 Screw Joint
786-1245 L-Key Joint
45° angled for easy access
to posterior areas.
Cuts ligature wire up to 0.36mm



ARTICULATORS

- Артикуляторы
- Artocilar
- Artikulations

- Артикулятори
- Articuler
- آرتیکولاتورس



786-1246
Full Arch
Chrome Plated



786-1247
Crowend Bridge
Chrome Plated



786-1248
Full Denture
Chrome Plated



786-1249
Full Arch
Chrome Plated



786-1250
Denture
Chrome Plated



786-1251



MALLETS - PLASTER SHEARS - SAWS & BLADES

- киянка - штукатурка ножиці - пили та леза
- Mailloches - plâtre Cisaille - Scies et lames
- Mazos - Tijeras Yeso - Sierras y cuchillas
- Молотках - штукатурка ножницы - пилы и лезвия
- Mazzuoli - Cesoiè Gesso - Seghe e lame
- مطارق - المقصص جص - مناشير وشفرات



Horn tip

786-1252
200 mm



Metal tip

786-1253
220 mm



Metal tip

786-1254
220 mm



For Plaster for metal.



786-1255
fret saw 250 mm



Plastic Handle

786-1256
200 mm

st. steel plaster shears



786-1257 250 mm
786-1258 320 mm
Crucible tongs.



786-1259
180 mm



0, 12x5 mm



0, 25x5 mm



0, 25x3 mm



LABORATORY SET

- лабораторії,
- laboratoire Panoplie
- Laboratorio Conjunto
- лаборатории,
- laboratorio Imposta
- مجموعة مختبر



786-1260
Set of 14 Pieces



786-1261
Set of 14 Pieces



TONGUE HOLDING FORCEPS

- Мова Холдинг пинцет
- Davier langue
- Pinzas de sujeción de la lengüeta

- Язык Холдинг пинцет
- Tongue Pinza
- الملقط اللسان القابضة



RUSSIAN TISSUE
FORCEPS
786-1262 6", 15cm
786-1263 8", 20cm



MAGILL FORCEPS
786-1264 Child - 7-1/2", 19cm
786-1265 Adult - 9 3/4", 25cm



STERILIZING FORCEPS
786-1266 Straight, 8", 20cm



YOUNG TONGUE
SEIZING FORCEPS
786-1267 With Rubber Jaws,
6-1/4", 16cm
786-1268 Replacement Tips 2/set



CHISELS
786-1269
5mm Flat Chisel,
45° Angle, 6", 15cm



MISCELLANEOUS PRODUCTS, ORTHODONTIC INSTRUMENTS

- Різні продукти, ортодонтичні інструменти
- Разные продукты, ортодонтические инструменты
- Produits divers, orthodontie instruments
- Prodotti vari, strumenti ortodontici
- Productos Varios, Instrumentos de ortodoncia
- منتجات متنوعة، آلات لتقويم الأسنان

Bracket Holder Tweezers



786-1270
X-ray Holder
Clip Single



786-1271
Bracket Placer
Tweezers
(Extra Fine Tip)



786-1272
Easy Ecess
Tweezers



786-1273
Slipper
Tweezers



786-1274
Deluxe Bracket
Holder Tweezers



786-1275
Deluxe Bracket
Holder Tweezers



786-1276
Bracket Tweezers
Slot Aligner



786-1277
Direct bonding
bracket holders
135mm



786-1278
Direct Bond Bracket
Holder Tweezers



786-1279
Direct Bond
Bracket Holder
Tweezers, Small Tip



786-1280
Exact Bracket
Holder Tweezers



ORTHODONTIC INSTRUMENTS

- Инструменты ортодонтические
- Instrumentos Ortodonticos
- Orthodontische Instrumente
- Инструменти ортодонтичні
- Instruments Orthodontiques
- أدوات تقويم الأسنان

Caliper / Calipers Rule



786-1281
Delux Boley
Gauge



786-1282
Boley Gauge



786-1283
Beerendonk
130mm
Mini Gauge



786-1284
for .018" slot
Bracket positioning
Gauges



786-1285
for .022" slot
Bracket positioning
Gauges



786-1286
OSTEOMETER
Measuring Forceps For Jaw Ridge Width
measurement, scale on both sides,
rustfree, autoclavable



PLIERS FOR ORTHODONTICS & PROSTHETICS

- Щипцы для ортодонтии и протезирования
- Pincers pour l'orthodontie et la prothèse
- Zangen für Kieferorthopädie und Prothetik

- Щипці для ортодонції та протезування
- Alicates para ortodoncia y prótesis
- كماشة لتقويم الأسنان برومشتيس



786-1287
Bracket Removing Pliers



786-1288
Bracket Removing Pliers



786-1289
Band removing pliers



786-1290
Band removers curved, Left and Right
Curved tips provide easy access and
grip of band without excess retractor
of cheek or tips



786-1291
Left



786-1292
Right
Pliers for Bands



786-1293
Johnson
Contouring Pliers



786-1294
Reynolds
Contouring Pliers



786-1295
For band seating



786-1296
for incisors with convex beaks



786-1297
For bicuspid and molars
with concave beaks

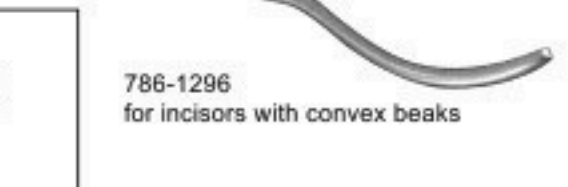



PLIERS FOR ORTHODONTICS & PROSTHETICS

- Щипцы для ортодонтии и протезирования
- Pincers pour l'orthodontie et la prothèse
- Zangen für Kieferorthopädie und Prothetik

- Щипці для ортодонції та протезування
- Alicates para ortodoncia y prótesis
- كماشة لتقويم الأسنان برومشتيس



786-1298
Straight
Pliers ball hook crimping



786-1299
Angled
Pliers ball hook crimping



786-1300
Micro distal end cutters T.C
with safety hold

●	Max. 0.30 mm to 0.50 mm (.012" to .020")
■	Max. 0.46 mm to 0.64 mm (.018" to .025")
⊗	Max. 0.38 mm to 0.53 mm (.0155" to .0215")
⊗	Max. 0.53 mm to 0.64 mm (.021" to .025")



786-1301
Mini distal end cutters T.C
with safety hold

●	Max. 0.30 mm to 0.50 mm (.012" to .020")
■	Max. 0.46 mm to 0.64 mm (.018" to .025")
⊗	Max. 0.38 mm to 0.53 mm (.0155" to .0215")
⊗	Max. 0.53 mm to 0.64 mm (.021" to .025")



786-1302
Mini with long handles T.C
distal end cutters with safety hold

●	Max. 0.30 mm to 0.50 mm (.012" to .020")
■	Max. 0.46 mm to 0.64 mm (.018" to .025")
⊗	Max. 0.38 mm to 0.53 mm (.0155" to .0215")
⊗	Max. 0.53 mm to 0.64 mm (.021" to .025")



786-1303
Mini with extra long off-set handles T.C
distal end cutters with safety hold

●	Max. 0.30 mm to 0.50 mm (.012" to .020")
■	Max. 0.46 mm to 0.64 mm (.018" to .025")
⊗	Max. 0.38 mm to 0.53 mm (.0155" to .0215")
⊗	Max. 0.53 mm to 0.64 mm (.021" to .025")

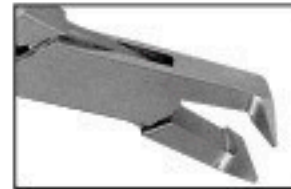

786-1304
Distal end bending pliers

●	Max. 0.30 mm to 0.50 mm (.012" to .020")
■	Max. 0.56 mm to 0.71 mm (.022" to .028")



786-1305
Weingart mini
slim design for better accessibility
in posterior and lingual areas



786-1306
Weingart Narrow
Narrow long tips for better
access to hard to reach areas



786-1307
Weingart Utility Pliers
Standard



PLIERS FOR ORTHODONTICS & PROSTHETICS

- Щипцы для ортодонтии и протезирования
- Pincers pour l'orthodontie et la prothèse
- Zangen für Kieferorthopädie und Prothetik

- Щипці для ортодонції та протезування
- Alicates para ortodoncia y prótesis
- كماشة لتقويم الأسنان برومشتيس



786-1308
Weingart Narrow
Slim and sleek design with long handles, for better access to posterior area, also suitable for lingual technique



786-1309
Micro
Ligature cutters
● .23 mm to .30 mm (.009" to .012")

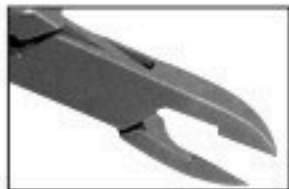

786-1310
Mini
Ligature cutters
● .25 mm to .38 mm (.010" to .015")



786-1311
Wire bending and loop forming pliers
Angel
● 0.36 mm to 0.71 mm (.014" to .028")
■ Max. 0.56 mm x 0.71 mm (.022" to .028")



786-1312
Wire cutting and loop forming pliers
Angel
● 0.36 mm to 0.50 mm (.014" to .020")
■ Max. 0.41 mm x 0.56 mm (.016" to .022")



786-1313
Straight

How utility pliers
Standard
4 mm wide tips



● 0.30 mm to 0.50 mm (.012" to .020")
■ Max. 0.56 mm x 0.71 mm (.022" to .028")

786-1314
Angled



786-1315
Straight

How utility pliers
Mini
2.4 mm wide tips



● 0.30 mm to 0.50 mm (.012" to .020")
■ Max. 0.56 mm x 0.71 mm (.022" to .028")

786-1316
Angled



IMPLANTOLOGY

- Инструменты для имплантологии
- Implantologie
- Implantologie

- Інструменти для імплантології
- Implantologia
- زراعة الأسنان

Calipers



786-1317
MEASURING
GAUGE
0-10cm



786-1318
CASTROVIEJO CALIPERS
20mm, 45°
90mm



786-1319
CASTROVIEJO CALIPERS
20mm
90mm



786-1320
CASTROVIEJO CALIPERS
20mm
90mm



786-1321
Bone Thickness Gauge
40mm
180mm



786-1322
Bone Caliper
Double Scale



786-1323
Weiss Modified
Castroviejo
Calipers
0-40mm
17cm 6 3/4"



786-1324
Castroviejo
Calipers
Straight
0-40mm
18cm 7"



786-1325
Castroviejo
Calipers
Angled
0-40mm
18cm 7"



PLIERS FOR ORTHODONTICS & PROSTHETICS

- Щипцы для ортодонтии и протезирования
- Pincés pour l'orthodontie et la prothèse
- Zangen für Kieferorthopädie und Prothetik

- Щипці для ортодонції та протезування
- Alicates para ortodoncia y prótesis
- كماشة لتقويم الأسنان برومشتیتس



786-1326
Mini head distal end cutter with safety hold, long handles fitted with un-breakable, corrosion resistant and durable stainless steel tips

●	0.30 mm to 0.50 mm (.012" to .020")
■	Max. 0.46 mm x 0.64 mm (.018" x .025")
⊗	0.38 mm to 0.53 mm (.0155" to .0215")
⊗	Max. 0.53 mm x 0.64 mm (.021" x .025")



786-1327
Hard wire cutter, 15° angled fitted with un-breakable, corrosion resistant and durable stainless steel tips

●	0.30 mm to 0.50 mm (.012" to .020")
■	Max. 0.56 mm x 0.71 mm (.022" to .028")



786-1328
Soft wire and ligature cutter, Mini fitted with un-breakable, corrosion resistant and durable stainless steel tips

⌋	.25 mm to .38 mm (.010" to .015")
---	-----------------------------------



786-1329
Band removing pliers



786-1330
Band removing pliers with plastic tip



786-1331
Weingart
Utility pliers

●	0.30 mm to 0.50 mm (.012" to .020")
■	Max. 0.56 mm x 0.71 mm (.022" to .028")



786-1332
Standard distal end cutter with safety hold fitted with un-breakable, corrosion resistant and durable stainless steel tips

●	0.30 mm to 0.50 mm (.012" to .020")
■	Max. 0.56 mm x 0.71 mm (.022" to .028")



786-1333
Mini head distal end cutter with safety hold fitted with un-breakable, corrosion resistant and durable stainless steel tips



●	0.30 mm to 0.50 mm (.012" to .020")
■	Max. 0.46 mm x 0.64 mm (.018" x .025")
⊗	0.38 mm to 0.53 mm (.0155" to .0215")
⊗	Max. 0.53 mm x 0.64 mm (.021" x .025")



PLIERS FOR ORTHODONTICS & PROSTHETICS



- Щипцы для ортодонтии и протезирования
- Pincers pour l'orthodontie et la prothèse
- Zangen für Kieferorthopädie und Prothetik

- Щипці для ортодонції та протезування
- Alicates para ortodoncia y prótesis
- كماشة لتقويم الأسنان برومشتیتس



786-1334
Distal end cutter with safety hold, mini head, long handles.
fitted with un-breakable, corrosion resistant and durable stainless steel tips

- 0.30 mm to 0.50 mm (.012" to .020")
- Max. 0.46 mm x 0.64 mm (.018" x .025")
- ⊗ 0.38 mm to 0.53 mm (.0155" to .0215")
- ⊗ Max. 0.53 mm x 0.64 mm (.021" x .025")



786-1335
Flush-cut distal end cutter with safety hold fitted with un-breakable, corrosion resistant and durable stainless steel tips

- 0.30 mm to 0.50 mm (.012" to .020")
- Max. 0.46 mm x 0.64 mm (.018" to .025")



786-1336
Soft wire and ligature cutter, Mini fitted with un-breakable, corrosion resistant and durable stainless steel tips

- ┌ .25 mm to .38 mm (.010" to .015")



786-1337
Soft wire and ligature cutter, standard fitted with un-breakable, corrosion resistant and durable stainless steel tips

- ┌ .25 mm to .38 mm (.010" to .015")



786-1338
Soft wire and ligature cutter, 15° angled fitted with un-breakable, corrosion resistant and durable stainless steel tips

- ┌ .25 mm to .38 mm (.010" to .015")



786-1339
Soft wire and ligature cutter, 45° angled fitted with un-breakable, corrosion resistant and durable stainless steel tips

- ┌ .25 mm to .38 mm (.010" to .015")



786-1340
Hard wire cutter, straight
Fitted with un-breakable, corrosion resistant and durable stainless steel tips

- 0.30 mm to 0.50 mm (.012" to .020")
- Max. 0.56 mm x 0.71 mm (.022" x .028")

786-1341
Hard wire cutter, 15° angled
Fitted with un-breakable, corrosion resistant and durable stainless steel tips

- 0.30 mm to 0.50 mm (.012" to .020")
- Max. 0.56 mm x 0.71 mm (.022" x .028")

786-1342
Hard wire cutter, 15° angled
Non-autoclavable

- 0.30 mm to 0.50 mm (.012" to .020")
- Max. 0.56 mm x 0.71 mm (.022" x .028")



PLIERS FOR ORTHODONTICS & PROSTHETICS

- Щипцы для ортодонтии и протезирования
- Pincettes pour l'orthodontie et la prothèse
- Zangen für Kieferorthopädie und Prothetik

- Щипці для ортодонції та протезування
- Alicates para ortodoncia y prótesis
- كماشة لتقويم الأسنان برومشتيس



786-1343
Band removing pliers



786-1344
Bracket removing pliers angled



786-1345
Bracket removing pliers straight



786-1346
Bracket removing pliers with plastic tip



786-1347
Adhesive removing pliers



786-1348
Weingart-mini
Utility Pliers

● 0.30 mm to 0.50 mm (.012" to .020")
■ Max 0.56 mm x 0.71 mm (.022" x .028")

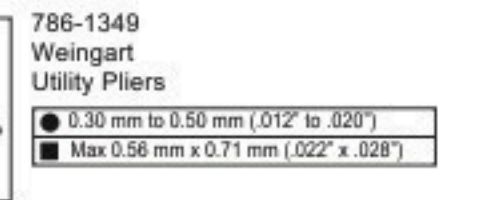

786-1349
Weingart
Utility Pliers

● 0.30 mm to 0.50 mm (.012" to .020")
■ Max 0.56 mm x 0.71 mm (.022" x .028")



786-1350
How Straight
Utility Pliers

● 0.30 mm to 0.50 mm (.012" to .020")
■ Max 0.56 mm x 0.71 mm (.022" x .028")

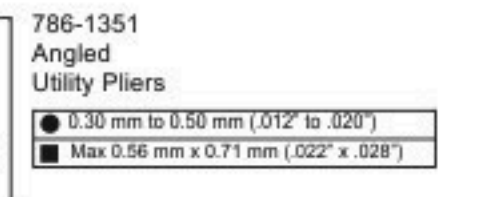

786-1351
Angled
Utility Pliers

● 0.30 mm to 0.50 mm (.012" to .020")
■ Max 0.56 mm x 0.71 mm (.022" x .028")



786-1352
Wire bending and loop forming pliers
Angled (Bird beak)

● 0.30 mm to 0.50 mm (.012" to .020")
■ Max 0.56 mm x 0.71 mm (.022" x .028")



PLIERS FOR ORTHODONTICS & PROSTHETICS

- Щипцы для ортодонтии и протезирования
- Pincettes pour l'orthodontie et la prothèse
- Zangen für Kieferorthopädie und Prothetik

- Щипці для ортодонції та протезування
- Alicates para ortodoncia y prótesis
- كماشة لتقويم الأسنان برومشتیتس



786-1353
Light wire bending and loop forming pliers

● 0.30 mm to 0.50 mm (.012" to .020")
■ Max 0.41 mm x 0.56 mm (.018" x .022")



786-1354
Light wire bending pliers with cutter fitted with hard metal tips

● 0.30 mm to 0.50 mm (.012" to .020")
■ Max 0.46 mm x 0.56 mm (.018" x .022")



786-1355
Light wire bending and loop forming pliers with cutter

● 0.30 mm to 0.50 mm (.012" to .020")
■ Max 0.46 mm x 0.56 mm (.018" x .022")



786-1356
Light wire bending and loop forming pliers, grooved tip

● 0.30 mm to 0.50 mm (.012" to .020")
■ Max 0.46 mm x 0.56 mm (.018" x .022")



786-1357
Tweed
Loop forming pliers with cutter

● 0.30 mm to 0.50 mm (.012" to .020")
■ Max. 0.53 mm x 0.64 mm (.021" x .025")



786-1358
Jarabak
Light wire bending pliers

● 0.30 mm to 0.50 mm (.012" to .020")
■ Max. 0.46 mm x 0.56 mm (.018" x .022")



786-1359
Aderer
3-jaw wire bending pliers

● 0.30 mm to 0.50 mm (.012" to .020")
■ Max. 0.56 mm x 0.71 mm (.022" x .028")



786-1360
Ligature forming pliers

∩ .25 mm to .38 mm (.010" to .015")



786-1361
Hollow-Chop
Archwire forming pliers, concave and convex tips

● 0.30 mm to 0.71 mm (.012" to .028")
■ Max. 0.56 mm x 0.71 mm (.022" x .028")





PLIERS FOR ORTHODONTICS & PROSTHETICS

- Щипцы для ортодонтии и протезирования
- Pincers pour l'orthodontie et la prothèse
- Zangen für Kieferorthopädie und Prothetik

- Щипці для ортодонтії та протезування
- Alicates para ortodoncia y prótesis
- كامشة لتقويم الأسنان برومشتيس



786-1362
Multi-purpose pliers, bird beak,
De la rosa and cutter in one

●	0.30 mm to 0.50 mm (.012" to .020")
■	Max. 0.46 mm x 0.56 mm (.018" x .022")



786-1363
Cinch Back / tie back
Distal end bending pliers

●	0.30 mm to 0.50 mm (.012" to .020")
■	Max. 0.56 mm x 0.71 mm (.022" x .028")



786-1364
Hammer head
Distal end bending pliers

●	0.30 mm to 0.50 mm (.012" to .020")
■	Max. 0.56 mm x 0.71 mm (.022" x .028")



786-1365
Nance
Loop forming pliers

●	0.36 mm to 0.71 mm (.014" to .028")
■	Max. 0.56 mm x 0.71 mm (.022" x .028")



786-1366
Detailing step pliers / Bayonet
bending pliers - 1mm

●	0.30 mm to 0.50 mm (.012" to .020")
■	Max. 0.56 mm x 0.71 mm (.022" x .028")



786-1367
Stop pliers V-Bebd - 1mm

●	0.30 mm to 0.50 mm (.012" to .020")
■	Max. 0.43 mm x 0.56 mm (.017" x .028")



786-1368
Lingual / palatal arch forming plies

●	0.76 mm (.030") / 0.91 mm (.036")
---	-----------------------------------



786-1369
Torquing pliers set



786-1370
Tweed / angel
Rectangular arch forming and
torquing pliers

●	0.30 mm to 0.71 mm (.012" to .028")
■	Max. 0.56 mm x 0.71 mm (.022" x .028")



786-1371
Surgical ball hook crimping pliers,
angled



786-1372
Surgical ball hook crimping
pliers, straight



PLIERS FOR ORTHODONTICS & PROSTHETICS

- Щипцы для ортодонтии и протезирования
- Pincers pour l'orthodontie et la prothèse
- Zangen für Kieferorthopädie und Prothetik

- Щипці для ортодонції та протезування
- Alicates para ortodoncia y prótesis
- كماشة لتقويم الأسنان برومشتیتس



786-1373
Adams
Wire bending pliers
● 0.30 mm to 0.81 mm (.014" to .032")
■ Max. 0.56 mm x 0.71 mm (.022" x .028")



786-1374
Adams
Wire bending pliers
● 0.30 mm to 0.81 mm (.014" to .032")
■ Max. 0.56 mm x 0.71 mm (.022" x .028")



786-1375
Universal small
Wire bending and cutting pliers
● Bends: 0.9 mm (.036")
■ Cuts: 0.7 mm (.028")



786-1376
Universal Dolphin style
Wire bending and cutting pliers
● Bends: 0.9 mm (.036")
■ Cuts: 0.7 mm (.028")



786-1377
Universal Taper style
Wire bending and cutting pliers
● Bends: 0.9 mm (.036")
■ Cuts: 0.7 mm (.028")



786-1378
Waldsachs
Wire bending and cutting pliers
● Bends: 0.9 mm (.036")
■ Cuts: 0.7 mm (.028")



786-1379
Hard wire cutters T.C.
● 0.70 mm to 1.00 mm (.028" to .040")



786-1380
Hard wire cutters T.C.
● 0.70 mm to 1.00 mm (.028" to .040")



786-1381
Hard wire cutters T.C.
● 0.60 mm to 0.80 mm (.024" to .032")



786-1382
Hard wire cutters T.C.
● 0.60 mm to 0.80 mm (.024" to .032")



786-1383
Hard wire cutters
● 0.87 mm to 1.1 mm (.028" to .045")



786-1384
Hard wire cutters
● 0.87 mm to 1.1 mm (.028" to .045")



PLIERS FOR ORTHODONTICS & PROSTHETICS

- Щипцы для ортодонтии и протезирования
- Pincettes pour l'orthodontie et la prothèse
- Zangen für Kieferorthopädie und Prothetik

- Щипці для ортодонції та протезування
- Alicates para ortodoncia y prótesis
- كماشة لتقويم الأسنان برومشتيس



786-1385
Aderer Clamp three jaw wire bending plier for contouring and bending wire up to .30"/0.76mm.



786-1386
Bird beak plier for bending round, square and rectangle wire up to .30"/0.76mm.

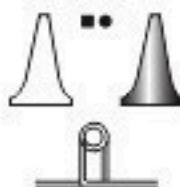

786-1387
Bird beak plier for light wire bending round, square and rectangular up to .016"/0.41mm.

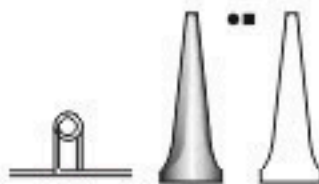

786-1388
Double Rounded jaw bending pliers, hooks and wire up to .020"/0.51mm.

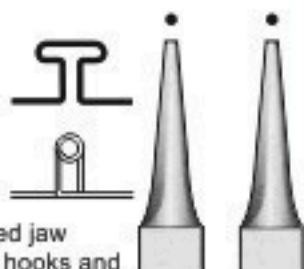

786-1389
Adams pliers for hooks and bending wire up to .030"/0.76mm.

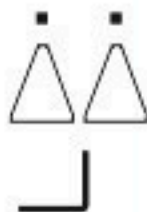

786-1390
Johnson pliers for crown band contouring



786-1391
Falcon beak contouring plier.

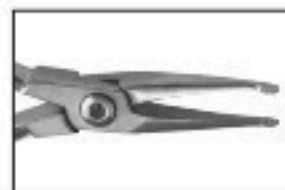

786-1392
For placement and removal of arch wires, pins and other auxiliaries.



786-1393
For placement and removal of arch wires, pins and other auxiliaries in angle design



786-1394
contouring Plier.



786-1395
Bending plier. In order to skirt molares bands. With grooved. Recommended wire. 016", 018" and 022" 0.41mm, 0.46mm and 0.56mm



PLIERS FOR ORTHODONTICS & PROSTHETICS

- Щипцы для ортодонтии и протезирования
- Pincés pour l'orthodontie et la prothèse
- Zangen für Kieferorthopädie und Prothetik

- Щипці для ортодонтії та протезування
- Alicates para ortodoncia y prótesis
- كماشة لتقويم الأسنان برومشتيس



786-1396
Loop forming in four length
3,4,5 & 6 mm wire capacity
0.22" / 56mm.

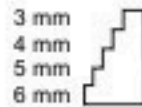

786-1397
Arch bending plier design for
convenient handling of square or
rectangular wire, .020" / 0.51mm.



786-1398
In order to skirt
bands and crowns.



786-1399
Wires up to
.020" / 0.7mm.



786-1400
Round and concave plier
for loop forming and banding
wire up to .20" / .051mm.

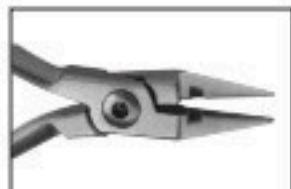

786-1401
Bending for round square
or rectangular wire up
to 0.30"/0.76mm

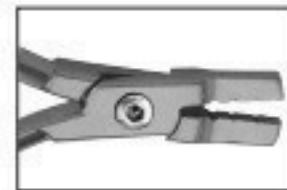

786-1402
for double back and triple
back bands in 0.30" / .76mm
& 0.36" / .91mm lingual arch wires.

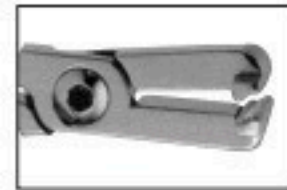

786-1403
Detailing step plier double-sided
offset beak permits bayonet bends.
Creates right hand or left hand
step-up or stepdown at 1/8, 1/4, or
1mm increments.

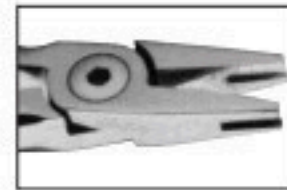

786-1404
"V" bend stop special design makes
1mm "v" bends to shorten archwires
or provide a positive stop. Excellent
for placing stops in titanium wires.
For round or rectangular wires up to .025"

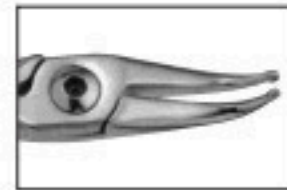

786-1405
Angle how plier efficient utility plier
with serrated beaks for a firm grip.
45 angled tips to access hard to
reach areas.

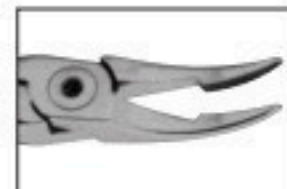

786-1406
Weingardt plier serrated tips hold
wires firmly at a convenient working
angle. Tapered beaks fit easily
between brackets and hard to reach
areas. Our most popular utility plier.



IMPLANTOLOGY

- Инструменты для имплантологии
- Implantologie
- Implantologie

- Інструменти для імплантології
- Implantologia
- زراعة الأسنان

Papilla Elevators

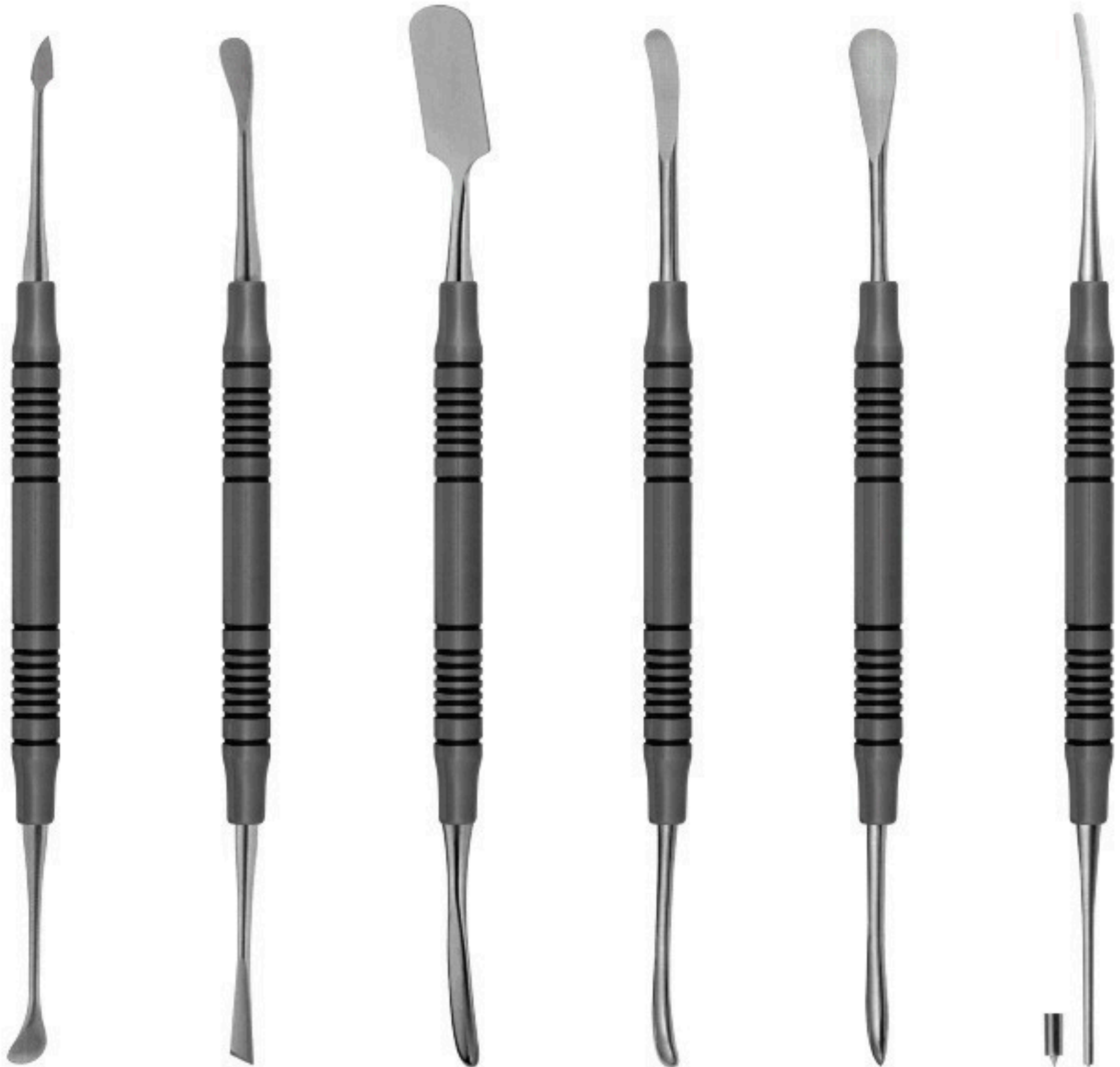

786-1407
BUSER
175 mm

786-1408
175 mm

786-1409
PRICHARD 3S
180 mm

786-1410
GOLDMANN FOX 14
175 mm

786-1411
MOLT 9
175 mm

786-1412
PLACEMENT
INSTRUMENTS
175 mm



IMPLANTOLOGY

- Инструменты для имплантологии
- Implantologie
- Implantologie

- Інструменти для імплантології
- Implantologia
- زراعة الأسنان

Sinus Lift Instruments:

Stainless steel, light weight handles Reduce hand and wrist fatigue Variety of elevators and curettes available Provides clinicians with the proper instrumentation for lifting the sinus membrane

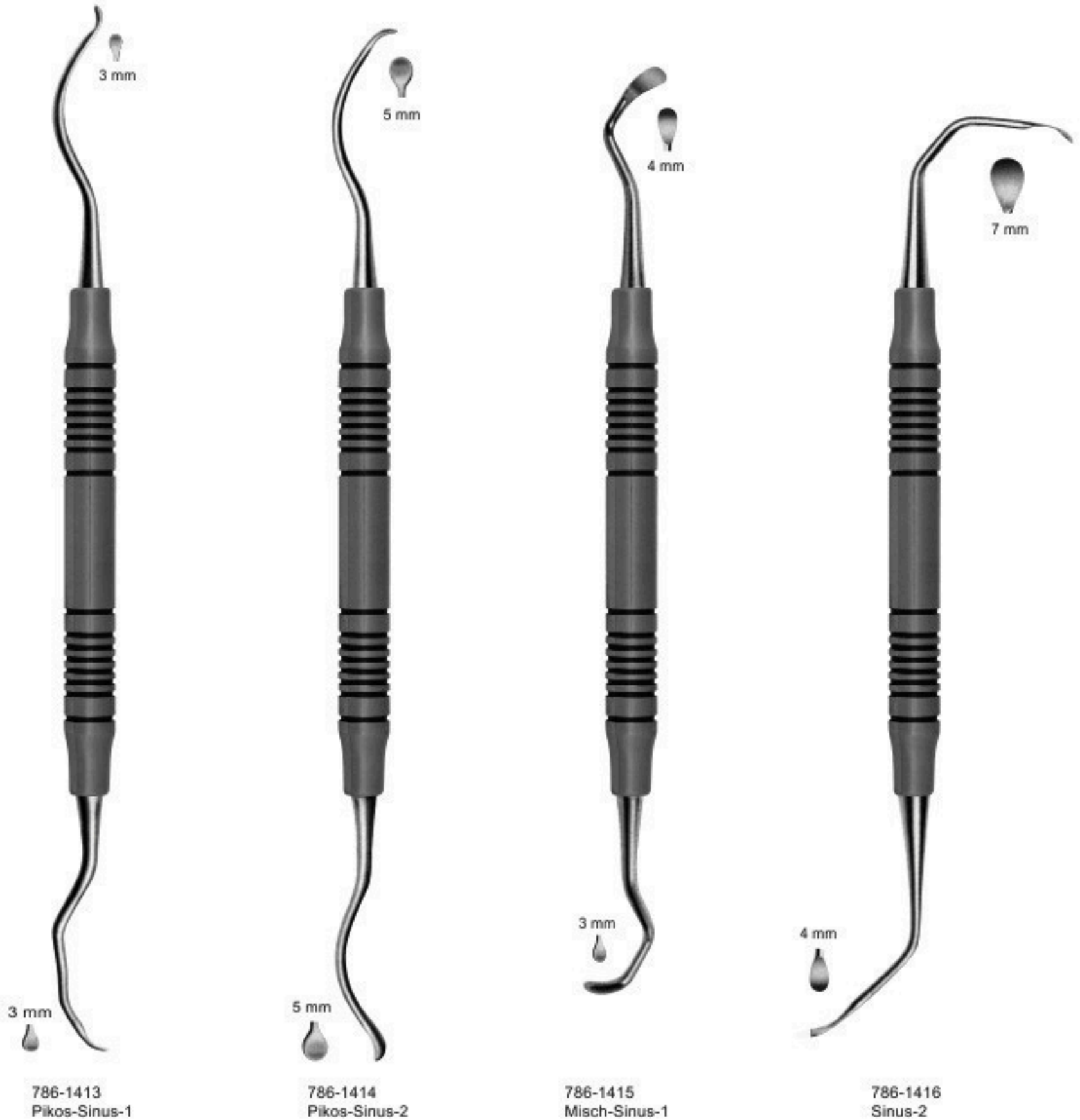



IMPLANTOLOGY

- Инструменты для имплантологии
- Implantologie
- Implantologie

- Інструменти для імплантології
- Implantologia
- زراعة الأسنان

Sinus Lift Instruments



786-1417
Mills-Sinus-1



786-1418
Mills-Sinus-2



786-1419
Mills-Sinus-3



786-1420
Sinus-4



IMPLANTOLOGY

- Инструменты для имплантологии
- Implantologie
- Implantologie

- Інструменти для імплантології
- Implantologia
- زراعة الأسنان

Sinus Lift Instruments

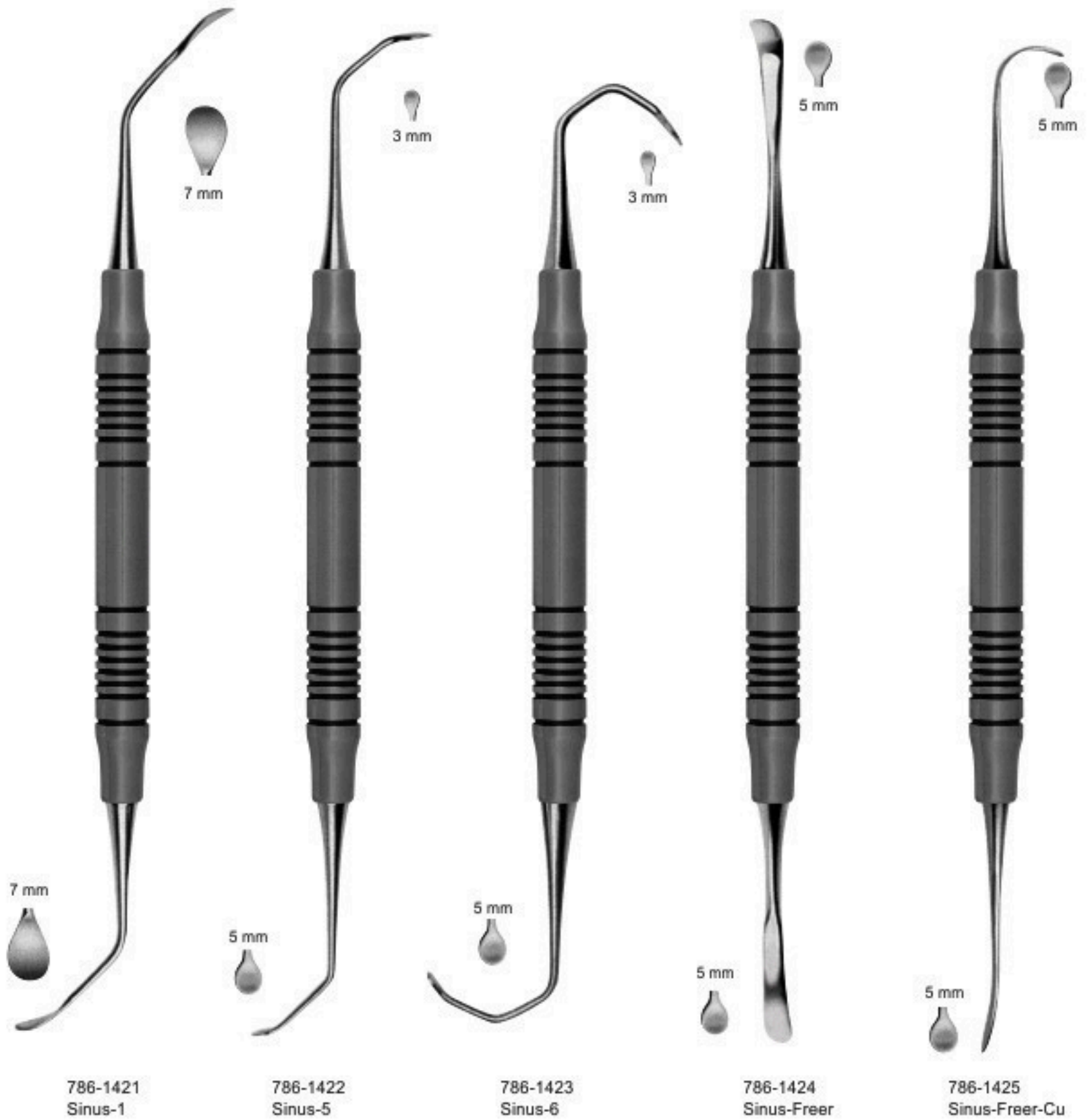



IMPLANTOLOGY

- Инструменты для имплантологии
- Implantologie
- Implantologie

- Инструменти для імплантології
- Implantologia
- زراعة الأسنان

Implant & Membrane Surgical Kit



786-1426
Scalpel
Handle



786-1427
Lucas
Surgical
Curette



786-1428
1/2
Buser Modified
Peeriodontal



786-1429
2/3
Buser Modified
Peeriodontal



786-1430
1/3
Buser Modified
Peeriodontal



786-1431
9A
Periosteal



786-1432
Buser
Periosteal



786-1433
221
Darby-Perry
Excavator



IMPLANTOLOGY

- Инструменты для имплантологии
- Implantologie
- Implantologie

- Інструменти для імплантології
- Implantologia
- زراعة الأسنان

Kramer-nevins Sinus Lift Kit



SL6F
175mm

786-1434
Spare blade, curved 155mm

SL5F
175mm

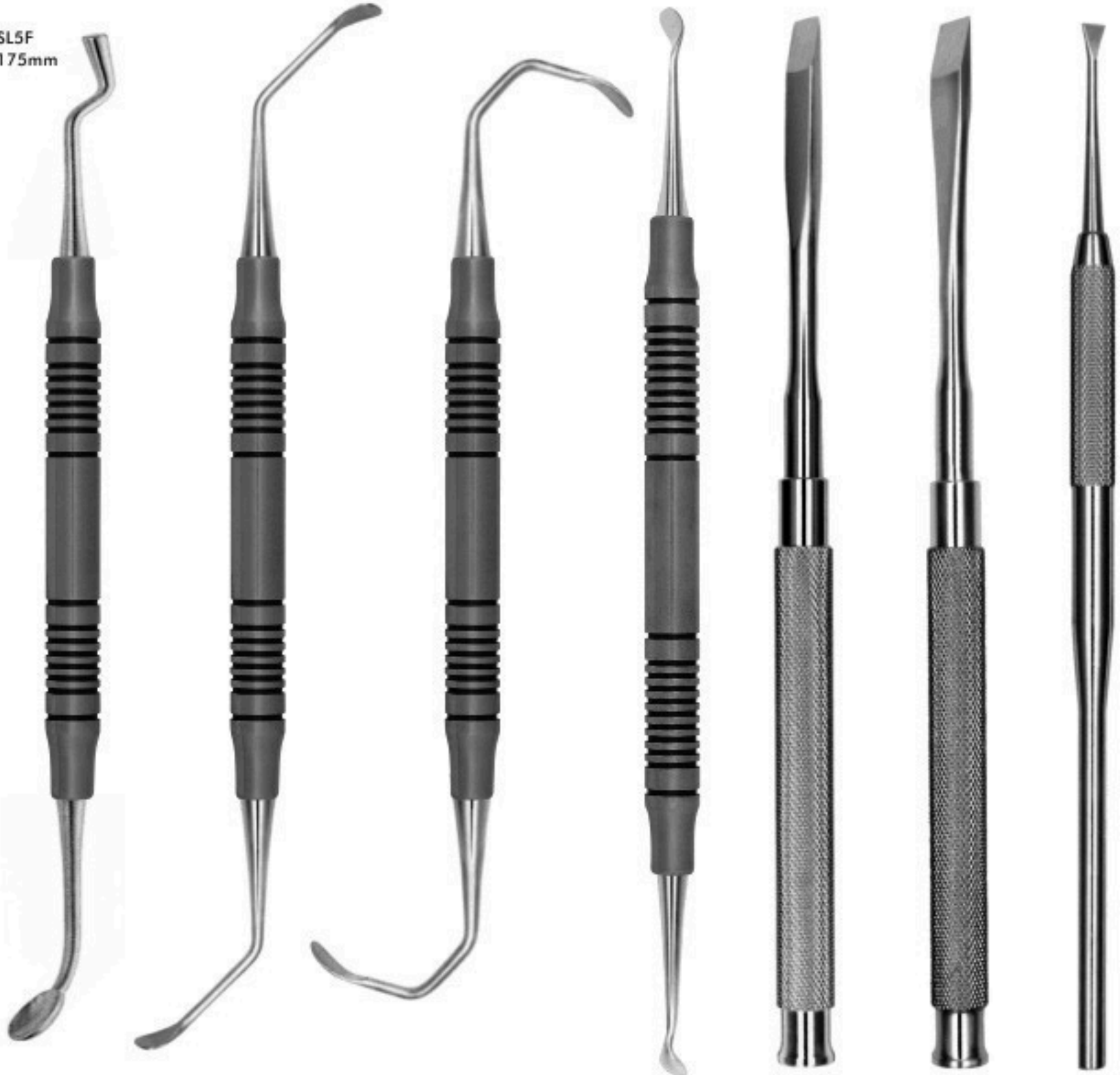

786-1435
Bone Scraper, curved
of stainless steel
155mm

786-1436
Sinus Lift
Instruments
Acute

786-1437
Sinus Lift
Instruments
Obtuse

786-1438
Kramer-Nevins
Periosteal

786-1439
Kramer-Nevins
Bone Chisel

786-1440
Kramer-Nevins
Bone Chisel

786-1441
Edentulous
ridge chisel



IMPLANTOLOGY

- Инструменты для имплантологии
- Implantologie
- Implantologie

- Інструменти для імплантології
- Implantologia
- زراعة الأسنان

Periodontal & Bone Curettes



786-1442
Prichard 1/2
Universal
Perio Curette



786-1443
Kramer 1
Mesial
Perio Curette



786-1444
Kramer 2
Distal
Perio Curette



786-1445
Kramer 3
Universal
Perio Curette



IMPLANTOLOGY

- Инструменты для имплантологии
- Implantologie
- Implantologie

- Інструменти для імплантології
- Implantologia
- زراعة الأسنان



786-1446
Lucas Bone
Curettes 75



786-1447
Lucas Bone
Curettes 85



786-1448
Lucas Bone
Curettes 86



786-1449
Lucas Bone
Curettes 87



786-1450
Lucas Bone
Curettes 88



IMPLANTOLOGY

- Инструменты для имплантологии
- Implantologie
- Implantologie

- Інструменти для імплантології
- Implantologia
- زراعة الأسنان

Micro Surgery & Tunneling Instruments



786-1451
Tunneling
Elevator # 1
17.2 cm



786-1452
Tunneling
Elevator # 2
17.2 cm



786-1453
Orban 1/4
Short
17.2 cm



786-1454
Orban 1/4
Long
17.2 cm



786-1455
Younger Good 7/8
9.5 mm Wide Tip



IMPLANTOLOGY

- Инструменты для имплантологии
- Implantologie
- Implantologie

- Інструменти для імплантології
- Implantologia
- زراعة الأسنان

Micro Surgery & Tunneling Instruments Perio Micro Surgery Instruments

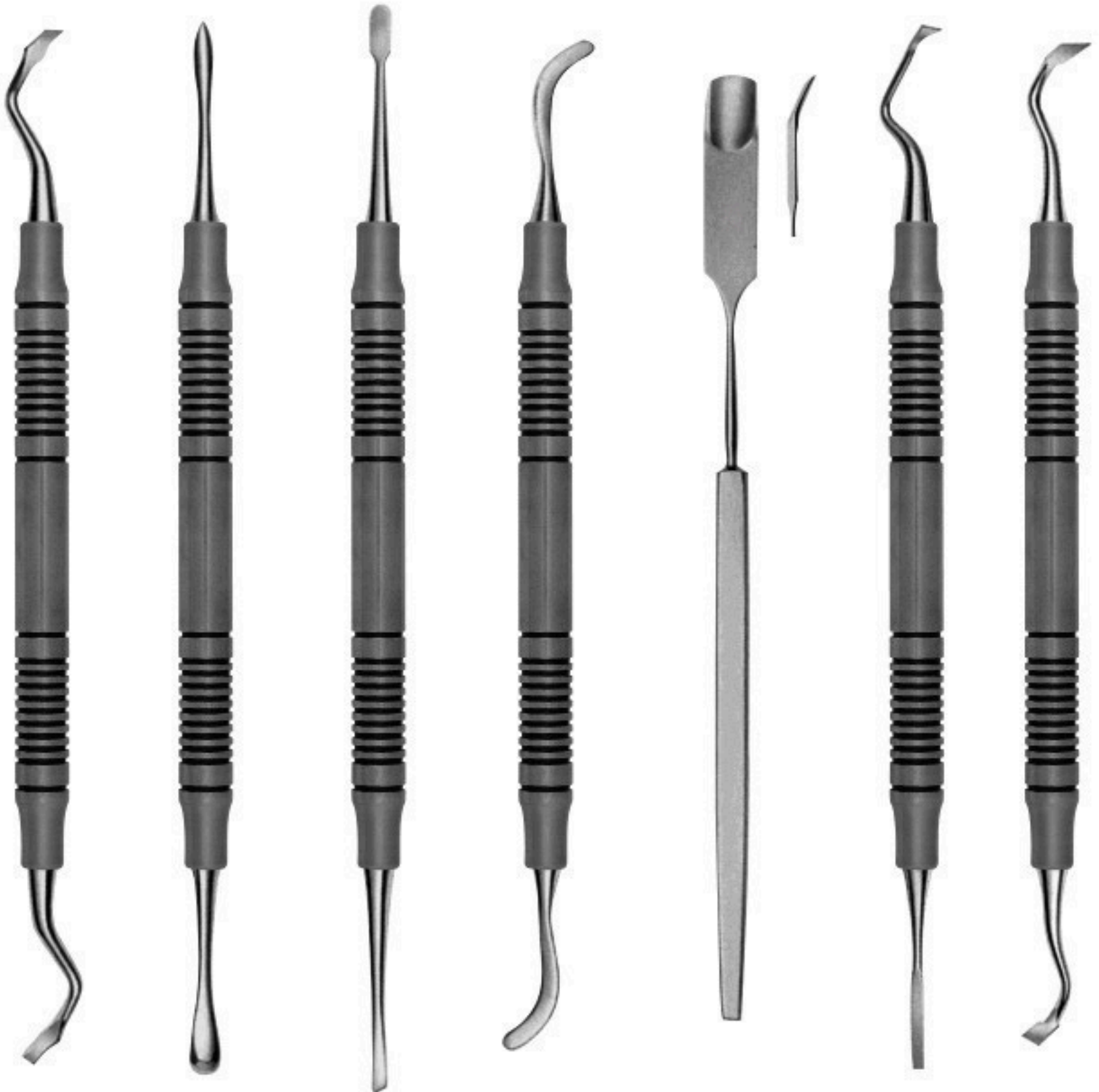

786-1456
Rhodes Chisel
17.2 cm

786-1457
Micro Elevator 1
17.2 cm

786-1458
Micro Elevator 2
17.2 cm

786-1459
Micro Elevator 3
17.2 cm

786-1460
Micro Retractor
9.5 mm Wide Tip

786-1461
Micro Chisel 1
17.2 cm

786-1462
Micro Chisel 2
17.2 cm



- Инструменты для имплантологии
- Implantologie
- Implantologie

- Інструменти для імплантології
- Implantologia
- زراعة الأسنان

Periosteal Elevators



786-1463
Freer



786-1464
Buser



786-1465
Quinn



786-1466
Hirschfeld 20



- Инструменты для имплантологии
- Implantologie
- Implantologie

- Інструменти для імплантології
- Implantologia
- زراعة الأسنان

Periosteal Elevators



786-1467
24G Elevator



786-1468
Henahan Retractor
Large



786-1469
West



786-1470
Woodson



IMPLANTOLOGY

- Инструменты для имплантологии
- Implantologie
- Implantologie

- Інструменти для імплантології
- Implantologia
- زراعة الأسنان

Periosteal Elevators



786-1471
Goldman-Fox Elevator
17cm



786-1472
Molt 2/4



786-1473
Molt 2 Angled
Double-Ended



786-1474
Molt 4 Angled
Double-Ended



786-1475
Molt 4 With
Suture Hole



786-1476
Molt 9



786-1477
Molt 2



786-1478
Molt 4



IMPLANTOLOGY

- Инструменты для имплантологии
- Implantologie
- Implantologie

- Інструменти для імплантології
- Implantologia
- زراعة الأسنان

Atraumatic Extraction Bayonet Root Elevators



786-1479
Bayonet Elevator
Straight



786-1480
Bayonet Elevator
Offset "In" Small



786-1481
Bayonet Elevator
Offset "Out" Small



786-1482
Bernard Bayonet Elevator
Offset Left



786-1483
Bernard Bayonet Elevator
Offset Right



IMPLANTOLOGY

- Инструменты для имплантологии
- Implantologie
- Implantologie

- Інструменти для імплантології
- Implantologia
- زراعة الأسنان

Implant Periosteals



786-1484
LaBanca



786-1485
LaBanca
Modified



786-1486
Buser



786-1487
PA



786-1488



786-1489
Sicilia



786-1490
Sicilia



IMPLANTOLOGY

- Инструменты для имплантологии
- Implantologie
- Implantologie
- Інструменти для імплантології
- Implantologia
- زراعة الأسنان

Implant Periosteals



786-1491
Sinus Lift
Instrument



786-1492
Sinus Lift
Instrument
3mm



786-1493
Sinus Lift
Instrument
3.5mm



786-1494
Zingheim
Knife



786-1495
Zingheim
Periosteal



786-1496
Zingheim
Periosteal



IMPLANTOLOGY

- Инструменты для имплантологии
- Implantologie
- Implantologie

- Інструменти для імплантології
- Implantologia
- زراعة الأسنان

Implant Chisels

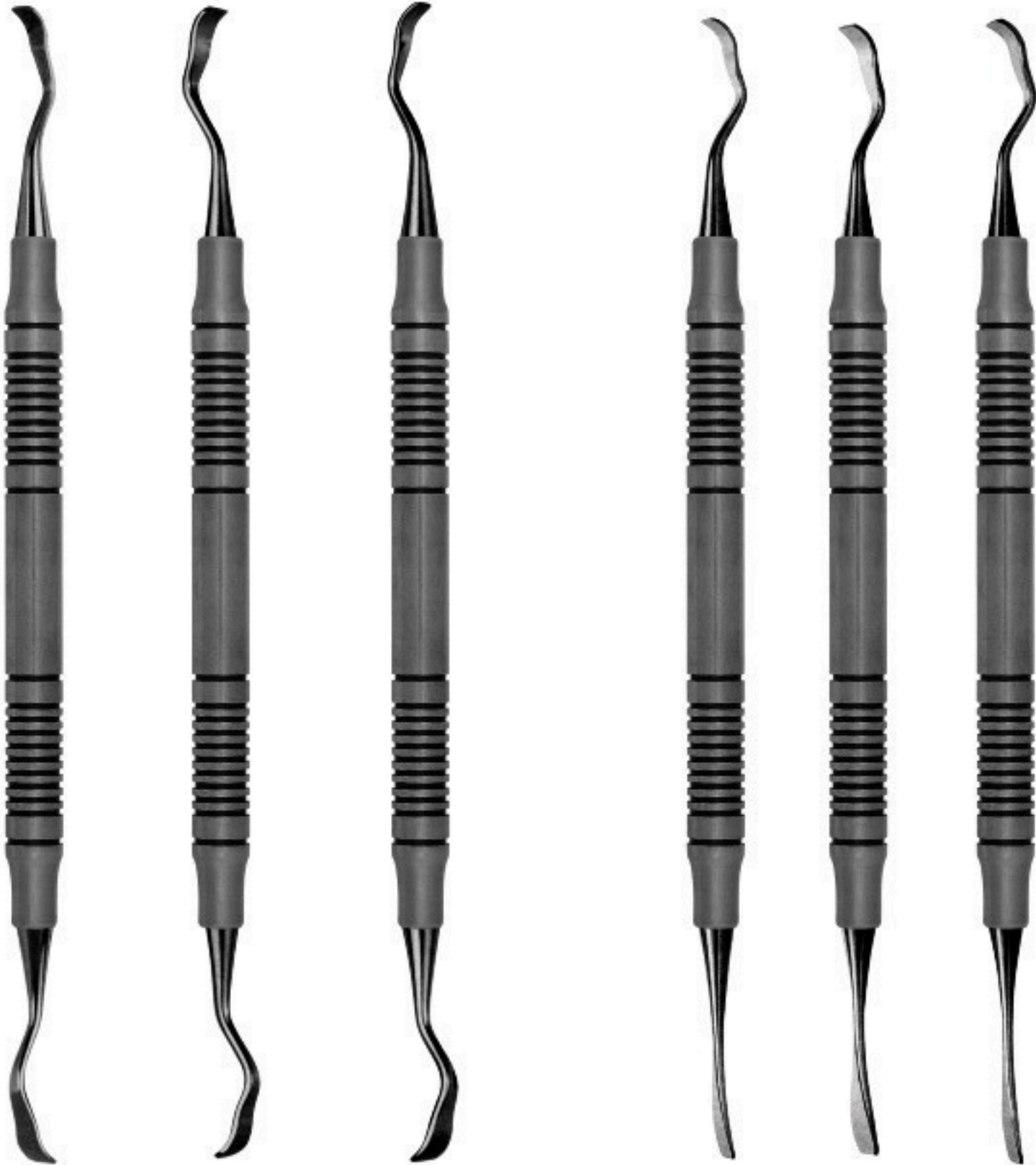

786-1497
Buser Modified
Periodontal
Chisel
3mm/4mm

786-1498
2/3
Buser Modified
Periodontal Chisel
4mm/5mm

786-1499
1/3
Buser Modified
Periodontal Chisel
3mm/5mm

786-1500
TG
Jovanovic
4mm

786-1501
TG
Jovanovic
5mm

786-1502
TG
Jovanovic
6mm



IMPLANTOLOGY

- Инструменты для имплантологии
- Implantologie
- Implantologie

- Інструменти для імплантології
- Implantologia
- زراعة الأسنان

Bone Scoops



786-1503
13KL
Palacci
Modified



786-1504
20mm
Probe



786-1505
Jovanovic
Bone Scoop



786-1506
Bone Graft
Scoop



786-1507
LaBanca
Bone Curette



786-1508
3x1.5mm
LaBanca



786-1509
Jovanovic



IMPLANTOLOGY

- Инструменты для имплантологии
- Implantologie
- Implantologie

- Інструменти для імплантології
- Implantologia
- زراعة الأسنان

Sinus Lift Instruments



786-1510
Kramer-Nevins
Acute



786-1511
Kramer-Nevins
Obtuse



786-1512
Sinus Lift
Instruments



786-1513
Single-End Sinus Lift
Instruments 3mm



786-1514
Sinus Lift
Instrument



IMPLANTOLOGY

- Инструменты для имплантологии
- Implantologie
- Implantologie

- Інструменти для імплантології
- Implantologia
- زراعة الأسنان

Bone Files



786-1515
Bone File 10



786-1516
Bone File 10CA



786-1517
Bone File 12



786-1518
Bone File 12CA



IMPLANTOLOGY

- Инструменты для имплантологии
- Implantologie
- Implantologie

- Інструменти для імплантології
- Implantologia
- زراعة الأسنان

Manual Bone Mill, Holding & Drilling Forceps

Ideal for Chairside Preparation of
Autogenous Bone Grafts
Bone Morselizer Bone Morselizer
786-1519 Bone morselizer

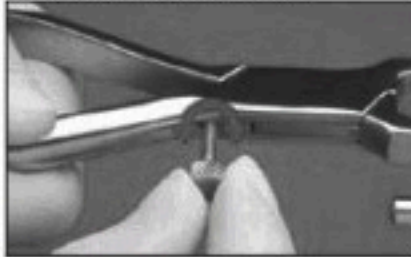

1. Adjust the spacing screw (located at the hinge of the handles) to the desired spacing requirements between knurled surfaces.

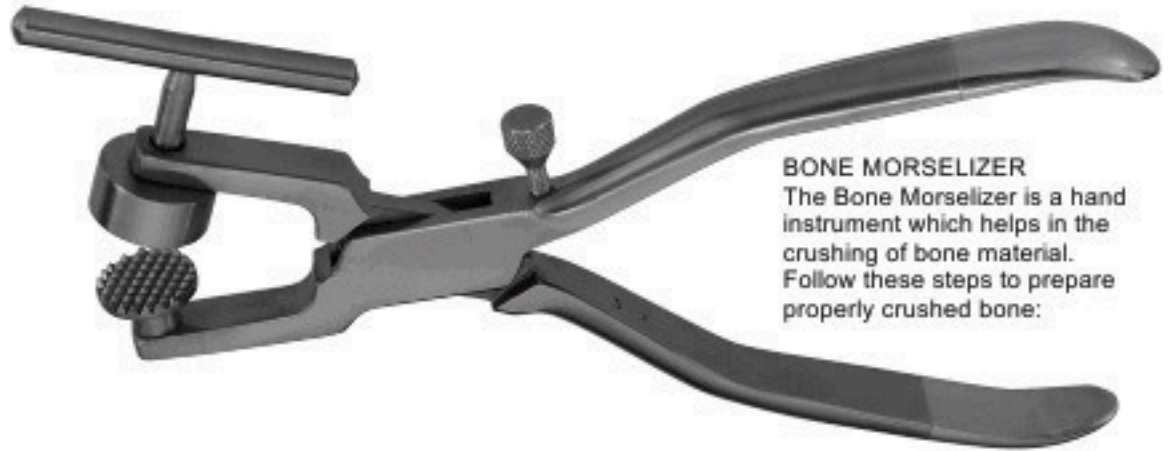

BONE MORSELIZER
The Bone Morselizer is a hand instrument which helps in the crushing of bone material. Follow these steps to prepare properly crushed bone:



2. Place the bone material into the bone well.



3. Compress handles together in order to create pressure on the bone material.



4. Turn the bone morselizer clockwise as the handles are squeezed. Always maintain a slight space between the two knurled surfaces, by using the spacing screw.



5. To remove bone, press the T-handle and bone will express from the bone well.

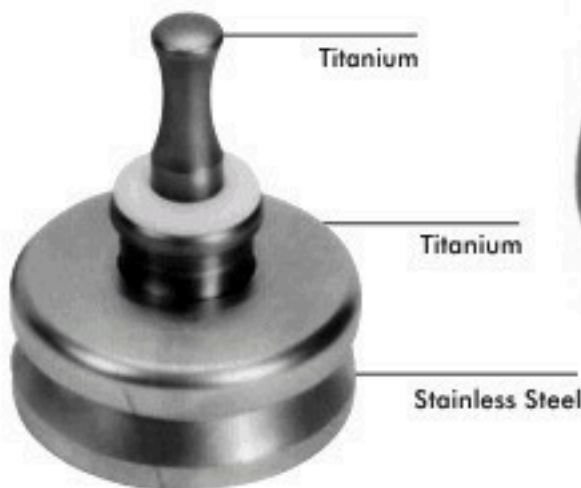

786-1520
EASY Bone Manual
Bone Mill to chop Bone
Fragments

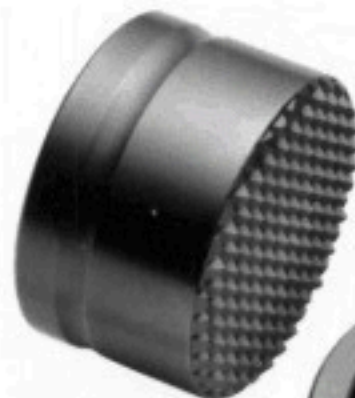

786-1521
Bone Mill



786-1522
Basins For Bone



IMPLANTOLOGY

- Инструменты для имплантологии
- Implantologie
- Implantologie

- Інструменти для імплантології
- Implantologia
- زراعة الأسنان

Bone Grafting Instruments Compactor /tampers

Product offering includes instruments for harvesting, mixing and compacting bone Provides clinicians with the proper instrumentation for bone grafting procedures Weighted bone basin Prevents tipping and spilling of bone and other materials during mixing



786-1523
GRAFT PACKER, CONCAVE
TIPS DE 4/6mm

786-1524
BONE SPOON/ PACKER DE 3mm

786-1525
GRAFT PACKER, SERRATED TIPS
DE 6/8mm

786-1526
GRAFT PACKER, SERRATED
TIPS DE 3/4mm



IMPLANTOLOGY

- Инструменты для имплантологии
- Implantologie
- Implantologie

- Інструменти для імплантології
- Implantologia
- زراعة الأسنان

Bone Grafting Instruments Compactor /tampers



786-1527
GRAFT PACKER, SMOOTH
TIPS DE 5/8mm



786-1528
Titanium graft packer / placement
site depth gauge 3.3mm & 4.0mm Diameter
tips Marked at 8, 11, 13, 15 & 18mm



786-1529
Graft Material Spoon With
3mm Serrated Graft Packer
Concave Spoon Tip For
Larger Grafts



786-1530
Graft Material Spoon
Concave Tip For
Larger Grafts



IMPLANTOLOGY

- Инструменты для имплантологии
- Implantologie
- Implantologie

- Інструменти для імплантології
- Implantologia
- زراعة الأسنان

TISSUE PUNCH

4.0mm ●



5.0mm ●



6.0mm ●



Stainless Steel Tissue
Punches - Straight
786-1531 4.0mm Straight Punch
786-1532 5.0mm Straight Punch
786-1533 6.0mm Straight Punch

2.0mm ●



786-1534

4.0mm ●



786-1535

5.0mm ●



786-1536

6.0mm ●



786-1537

7.0mm ●



786-1538

8.0mm ●



786-1539

Stainless Steel Tissue Punches - offset



IMPLANTOLOGY

- Инструменты для имплантологии
- Implantologie
- Implantologie

- Інструменти для імплантології
- Implantologia
- زراعة الأسنان

Extracting Forceps



786-1540



786-1541



786-1542



786-1543



786-1544



786-1545



IMPLANTOLOGY

- Инструменты для имплантологии
- Implantologie
- Implantologie

- Інструменти для імплантології
- Implantologia
- زراعة الأسنان

Extracting Forceps



786-1546



786-1547



786-1548



786-1549



786-1550



786-1551



786-1552



- Инструменты для имплантологии
- Implantologie
- Implantologie

- Інструменти для імплантології
- Implantologia
- زراعة الأسنان

Extracting Forceps



786-1553
Fig. 34



786-1554
Fig. 34A



786-1555
Fig. 35



786-1556
Fig. 35A



786-1557
Fig. 36



786-1558
Fig. 36A



786-1559



786-1560
Fig. 67



786-1561
Fig. 79



- Инструменты для имплантологии
- Implantologie
- Implantologie

- Інструменти для імплантології
- Implantologia
- زراعة الأسنان

Extracting Forceps



786-1562
Fig. 67A



786-1563
Fig. 79A



786-1564
Fig. 45Z



786-1565
Fig. 51Z



786-1566
Fig. 44Z



IMPLANTOLOGY

- Инструменты для имплантологии
- Implantologie
- Implantologie

- Інструменти для імплантології
- Implantologia
- زراعة الأسنان

Chisels / Osteotomes



786-1567 Ø 2.0mm
786-1568 Ø 2.7mm
786-1569 Ø 3.2mm
786-1570 Ø 4.2mm
786-1571 Ø 5.0mm
160mm



786-1572 Ø 2.0mm
786-1573 Ø 2.7mm
786-1574 Ø 3.2mm
786-1575 Ø 4.2mm
786-1576 Ø 5.0mm
160mm



786-1577 Ø 2.0mm
786-1578 Ø 2.7mm
786-1579 Ø 3.2mm
786-1580 Ø 4.2mm
786-1581 Ø 5.0mm
175mm



786-1582 Ø 2.0mm
786-1583 Ø 2.7mm
786-1584 Ø 3.2mm
786-1585 Ø 4.2mm
786-1586 Ø 5.0mm
175mm



STERILE WASH TRAY SYSTEM

- Стерильні Вимийте в системному треї
- Sterilные системном трее Мытье
- plateau système de lavage stérile
- Sterile barra delle applicazioni Lavare
- Estéril Sistema bandeja de lavado
- العقيمة عتبة النظام غسل

Steri Wash Tray System

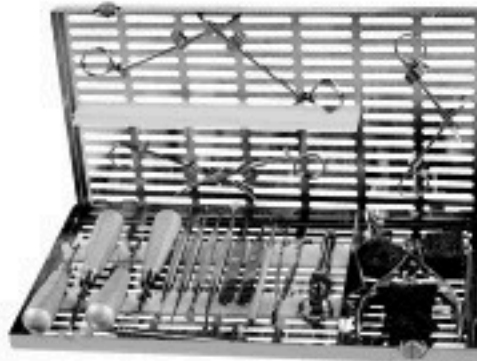

786-1587
Oral Surgery Kit (C)
Exterior Dimensions 14.5" x 8" x 1.25"
(368mm x 203mm x 32mm)

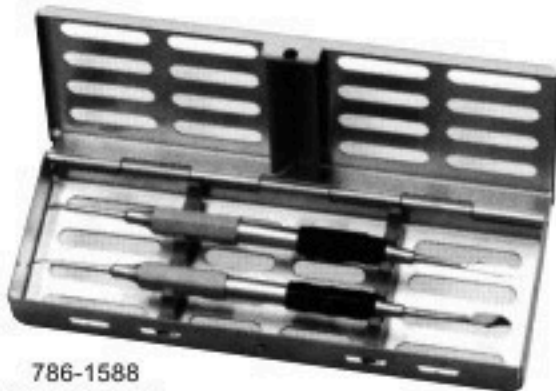

786-1588
Mini Cassette
For 5 Instruments
180 x 70 x 25 mm

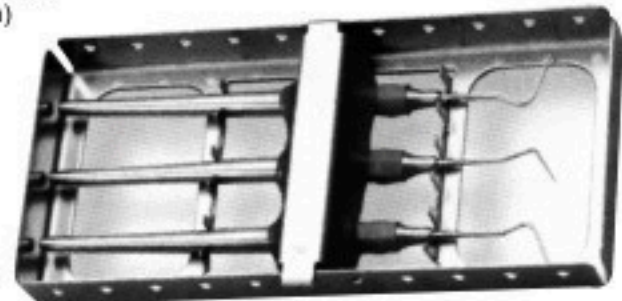

786-1589
Economy Cassette
For 5 Instruments
180 x 85 x 19 mm

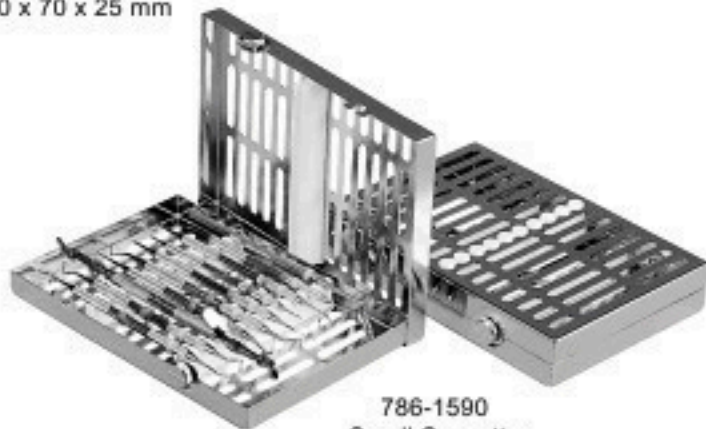

786-1590
Small Cassette
For 10 Instruments
140 x 203 x 32 mm



786-1591
Maxi Cassette
For 16 Instruments
280 x 180 x 30 mm



786-1592
Large Cassette
For 16 Instruments
230 x 280 x 32 mm
with an
Accessory Area



786-1593
Large Cassette
For 20 Instruments
230 x 280 x 32 mm



STERILE WASH TRAY SYSTEM

- Стерильні Вимийте в системному треї
- Sterilnyye sistemnom treye Mytye
- plateau système de lavage stérile
- Sterile barra delle applicazioni Lavare
- Estéril Sistema bandeja de lavado
- العقِيمَة علبَة النظام غسَل

Steri Wash Tray System

Easy To use
Fully Hygienic
Time Saving
Longer Instrument Lift
Modern & Practical Design



786-1594
Instruments Tray
Dimensions
182 x 72 x 34 mm



786-1595
Instruments Tray
Dimensions
182 x 144 x 34 mm



786-1596
Instruments Tray
Dimensions
288 x 182 x 34 mm

ECONOMY STERI WASH TRAY SYSTEM

Instrument Tray Complete with
Base, Lid, Silicon Insert Frame & Holder
Locking System

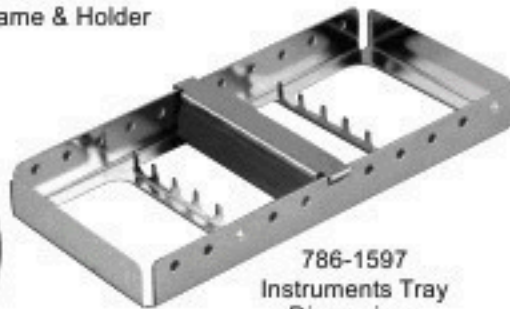
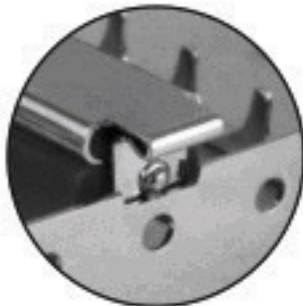

786-1597
Instruments Tray
Dimensions
182 x 144 x 34 mm



786-1598
Instruments Tray
Dimensions
182 x 144 x 34 mm

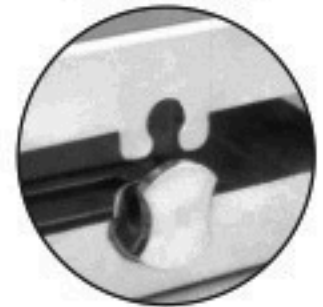

Locking System

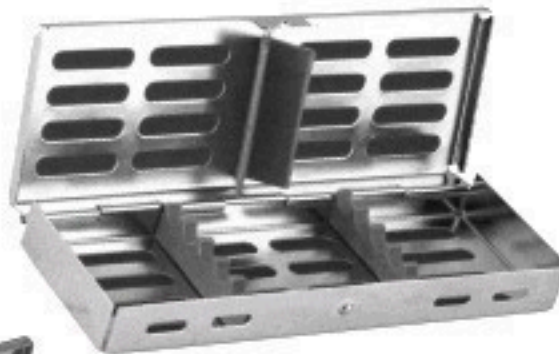

786-1599
Instruments Tray
Dimensions
185 x 65 x 22 mm



786-1600
Instruments Tray
Dimensions
185 x 130 x 22 mm



786-1601
Instruments Tray
Dimensions
280 x 180 x 25 mm



STERILE WASH TRAY SYSTEM

- Стерильні Вимийте в системному треї
- Sterile barra delle applicazioni Lavare
- Sterilnyye sistemnom treye Mytye
- Sterile barra delle applicazioni Lavare
- Estéril Sistema bandeja de lavado
- العقيمة عتبة النظام غسل

Steri Wash Tray System



Sizes:
 786-1602 240x130x50mm
 786-1603 240x130x60mm
 786-1604 240x250x50mm
 786-1605 240x250x60mm
 786-1606 480x250x50mm
 786-1607 480x250x60mm
 786-1608 480x250x70mm



Sizes:
 786-1616 240x250x50mm
 786-1617 240x250x60mm
 786-1618 240x250x70mm
 786-1619 280x250x50mm
 786-1620 280x250x60mm



MESH TRAYS
 Different sizes & dimensions
 are available at buyer's
 demand

SIZES:
 786-1609 240x250x50mm
 786-1610 240x250x60mm
 786-1611 240x250x70mm
 786-1612 480x250x50mm
 786-1613 480x250x60mm
 786-1614 480x250x70mm
 786-1615 480x250x100mm



Sizes:
 786-1621 280x250x70mm
 786-1622 280x250x100mm
 786-1623 280x250x50mm
 786-1624 280x280x60mm
 786-1625 280x280x70mm
 786-1626 300x280x60mm

MESH BASKET

786-1627 480 x 258 x 50 mm
 786-1628 480 x 258 x 100 mm
 786-1629 520 x 258 x 60mm
 786-1630 520 x 258 x 70mm
 786-1631 450 x 340 x 70mm
 786-1632 320 x 230 x 70mm

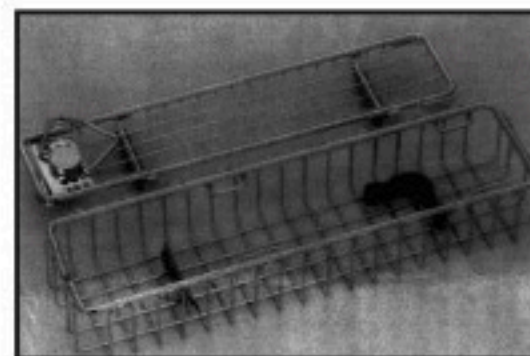
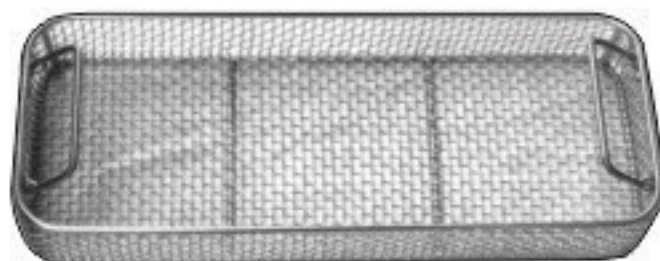

ARTHROSCOPE BASKET
 786-1655 290 x 80 x 52 mm

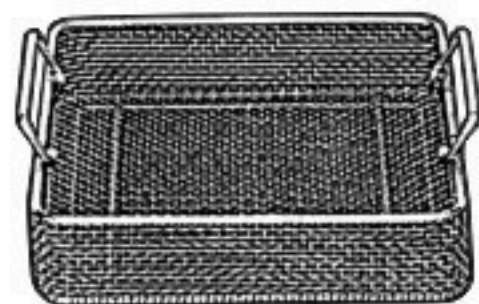

MESH BASKET

786-1633 240 x 258 x 50 mm
 786-1634 250 x 240 x 100 mm
 786-1635 240 x 250 x 60mm

MESH BASKET

With Perforated Sheet Side
 786-1636 230 x 130 x 50 mm
 786-1637 230 x 130 x 60 mm
 786-1638 240 x 130 x 50 mm
 786-1639 240 x 130 x 60 mm
 786-1640 240 x 250 x 50 mm
 786-1641 240 x 250 x 60 mm
 786-1642 480 x 250 x 50 mm
 786-1643 480 x 250 x 60 mm
 786-1644 480 x 250 x 70 mm
 786-1645 300 x 300 x 50 mm
 786-1646 350 x 350 x 60 mm
 786-1647 470 x 400 x 60 mm
 786-1648 480 x 480 x 50 mm
 786-1649 480 x 480 x 60 mm
 786-1650 500 x 300 x 50 mm
 786-1651 520 x 300 x 50 mm
 786-1652 520 x 300 x 60 mm
 786-1653 550 x 430 x 50 mm
 786-1654 600 x 300 x 60 mm

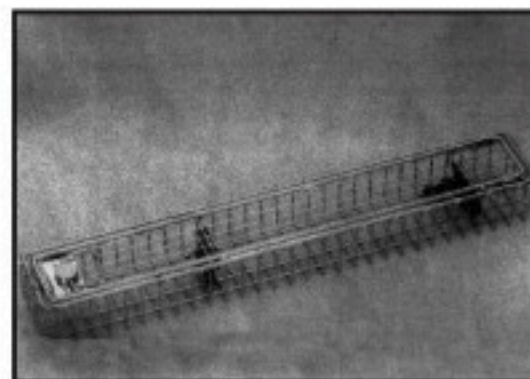

ENDOSCOPE BASKET
 786-1656 460 x 80 x 52 mm
 786-1657 660 x 80 x 52 mm
 786-1658 670 x 80 x 52 mm



KEY RINGS

- брелоки
- Porte-Clés
- Llaveros

- брелоки
- Portachiavi
- سلاسل المفاتيح



786-1659
Extracting Forceps, American Pattern. F/X



786-1664
Le Cron Carver.



786-1660
Extracting Forceps, American Pattern.



786-1665
Tweezers (Beauty)



786-1661
Extracting Forceps, English Pattern.



786-1666
Retractor.



786-1662
Root Elevator.



786-1667
Mirror Handle with Mirror.



786-1663
Nipper



KEY RINGS

- брелоки
- Porte-Clés
- Llaveros

- брелоки
- Portachiavi
- سلاسل المفاتيح



786-1668
Pliers. Young.



786-1669
Syringe Folding.



786-1670
Wason Caliper.



786-16741
Nasal Specula



786-1672
Dressing Tweezers.



786-1673
Scissor



786-1674
Needle Holder



786-1675
Impression Tray Perforated



786-1676
Impression Trays, Solid.

Precision®

Precision Instruments Care & Handling Specifications

- Brand new instruments should be cleaned prior to first sterilization.
- Contaminated instruments should be processed as soon as possible.
- Stubborn protein particles can be removed with a scrub brush. Do not use steel wool, abrasives or an acid rinse.
- Oil joints on instruments prior to preparation.
- Lubrication is vital to a long instrument life. Avoid silicon lubricants because they tend to build up and mix with debris to clog moving parts, which becomes almost impossible to remove. Debris buildup can have a "rust-like" appearance.
- Rinse your cleaned instruments in demineralized water. Be sure to remove all residual, cleaning compounds before sterilization, as they can cause stains.
- Dry the instruments thoroughly after rinsing.

PRECISION WARRANTY

We make every effort to enforce strict Quality Control Measures from drawing board to buying raw materials, hiring and maintaining the right work-force and to each and every step of manufacturing up to the shipping and deliveries of the finished goods.

These tight measures give us ultimate confidence to Offer all our customers LIFE-TIME Warranty on PREMIUM line and ONE YEAR Warranty on VALUE-LINE Instruments. If the instrument does not meet the requirements when used for its intended purpose, we will replace it.

Precision[®]

A Quality Assured Name

Quality You Can TRUST

We, at **Life Saver Supplies** would like to

THANK YOU

for taking time to browse through our catalog.

We realize we do not quite follow the norms.

We focus on expressing our total commitment to perfection, when it comes to production-be it a catalog or an instrument. We have tried to convey to you, our colleagues and friends that our instruments are designed to enhance your life so that you may continue with the beauty in life that it brings.

Precision - Perfection - Persistence

Precision Instruments

Life Saver Supplies - A division of
Life Saver Solutions, Inc.

4531 La Palma Ave, E-mail: info.lifesaver@gmail.com
Anaheim, CA 92807 Website: www.lifesaversuppliers.com

Authorised Distributor:



cGMP
Approved by FDA-USA

Precision[®]

A Quality Assured Name

CE

